

Design and Development of Islanding Detection Algorithm for Control of Microgrid

Dhayalini K*

*Department of EEE, K. Ramakrishnan College of Engineering, Trichy, India

*Corresponding author: E-Mail: dhaya2k@gmail.com, Tel: 0091-9952877028

ABSTRACT

Renewable resources can be used for the energy scarcity facing now. For the optimum usage of renewable resources, system called micro grid. It can be operated in two modes. In the normal condition the micro grid is connected to the utility grid. Current control is given during this mode to give preset power. In this mode, when there is any fault or maintenance in the main grid the micro grid is islanded either to prevent spreading of fault to the micro grid or to prevent accidents. When the intentional islanding is done, the control is given to maintain the voltage. Thus constant control is given to the loads during this mode. Depending on the generation of micro grid side the intelligent load shedding is implemented. The critical loads are maintained without any power quality issues. Simulation is performed using MATLAB \ Simulink software. Simulation of controls during different modes, islanding detection algorithm and intelligent load shedding are discussed in this paper.

KEY WORDS: Micro grid, Intentional Islanding, Intelligent Load Shedding, Islanding Detection Algorithm, Distributed generators.

1. INTRODUCTION

The main problems in today's power system are rising of energy demand, load limitations during peak hours, power quality issues, transmission and distribution losses, pollution due to the emission of CO₂ etc. This has led to an era in that the increasing power demand are going to be met by Distributed Generation (DG) system that are based on renewable energy sources like solar energy, wind power, small hydro power etc. For the optimum utilization of these renewable resources a brand new technology is introduced, known as MICROGRID.

Microgrid can be illustrated as a gathering of interconnected loads and distributed energy resources (DER) which have an unmistakably characterized electrical limits that acts as a single controllable entity regarding the network, that can interface and separate from the grid to enable it to operate in each grid connected or island mode.

The Microgrid idea expect a bunch of loads and micro sources working as a solitary controllable framework that gives both power and heat to its neighborhood. This idea gives another worldview to characterizing the operation of distributed generation. To the utility the Microgrid can be considered as a controlled cell of the power system. For instance this cell could be controlled as a solitary dispatchable load, which can react in seconds to address the issues of the transmission system. To the client the Microgrid can be intended to meet their exceptional needs, for example, upgrade nearby dependability, diminish feeder misfortunes, bolster neighborhood voltages, give expanded proficiency through use waste warmth, voltage list redress or give uninterruptible influence supply capacities to give some examples.

The micro sources of special interest for Micro grids are small (less than 100-kW) units with power electronic interfaces. These sources, (commonly smaller scale turbines, PV panels, and fuel cells) are put at clients destinations. They are low price, low voltage and have high reliable with few emissions. Power electronics give the control and adaptability required by the Microgrid idea. (Ahmed Abdalrahman, 2012) Correctly designed power electronics and controls insure that the Microgrid will meet its clients and the utility's needs. The above attributes will be achieved using system design with 3 important components: Local micro source controllers; System optimizer; Distributed protection.

A micro grid is an advanced electrical distribution system that has sophisticated aggregations of many parts and various supply sources. Thus, the interactions between them or with the power utility yield will cause temporary variations within the characteristics of the power supplied to the customer. Therefore, the quality of the power supply and technical challenges in a microgrid should be cleared. This problem usually happens in such systems and for both operation modes grid connected and islanding mode. Therefore, it is important to propose a control concept for both microgrid operation modes. In this the literature survey the technical challenges in a microgrid are mentioned as follows (Vandoorn, 2012).

2. EXPERIMENTAL SECTION

Operational Modes in Micro grid: There are two working modes of a Microgrid power system. (Hartono, 2013) Grid Connected Mode: When it is connected to the utility grid, the static switch is closed. All the feeders are being equipped by the utility grid, and Microgrid can be giving surplus power to the main grid. In islanding mode the utility grid does not provide power once the static switch is open. Microgrid can be operating alone preventing power outages once the utility grid isn't obtainable (Irvin, 2011; Lopes, 2009).

The purpose of common coupling is that the point wherever a Microgrid system is connected to the utility grid. Islanding mode will incorporate two working conditions: intentional islanding and unintentional islanding.

Micro grid Control Methods: To connect any DER to the utility, most systems utilize control strategies that are based on output current and frequency regulation; many of these uses the current regulation to control the real and reactive power delivered to/from a DER. Other methods of control include voltage and frequency droop to regulate the output current to the utility, multiple inverters in master/slave operation, and indirect voltage regulation are some examples.

In the early stages real and reactive power control were used. In this method the real power is controlled by adjusting the reactive power and vice versa. But in our power system it's not advisable to increase the reactive power because only the active power is that the useful power. Always it is desired to keep the reactive power minimum as possible. The controller types used were the voltage and frequency droop methods to regulate the output aren't a preferred method in control once dealing with 3 systems that are potentially (and more than likely) highly non-linear loaded.

The droop methods have their drawbacks in 3 phase systems; such as that they inherently produce small errors in the output and the system can never achieve zero steady-state error. Droop control methods cannot properly regulate harmonic distribution between the phases due to non-linear loads and line conditions as well. Line impedances for a 3 phase system significantly influence the reactive power of a system and cannot be easily solved by droop control techniques. Droop control is great for load sharing control for multiple converter systems. For 3 phase systems that have changes in topology (if intentional islanding is implemented), thus a change in control operation, the droop method is not a favorable choice; especially for 3 phase systems with both linear and non-linear loading characteristics (Marinescu, 2011).

Hybrid systems mix master/slave and droop control systems, which combine the useful features of each type of control while eliminating some of the undesirable ones; but like the classical droop control, when the hybrid method is used in a system that needs to change modes of operation due to a topological change in the system, it is not a favorable choice either (Micallef, 2012). Using direct regulation of the system states, current for grid-connected mode and voltage for islanding mode, along with various types of current injection techniques appears to be the best method for regulating systems with DER to utility interconnections and that implement intentional islanding.

The following control method has two distinct modes of control operation: current mode (IM) and voltage mode (VM). These control modes correspond to the systems operating mode, grid-connected or islanding (respectively).

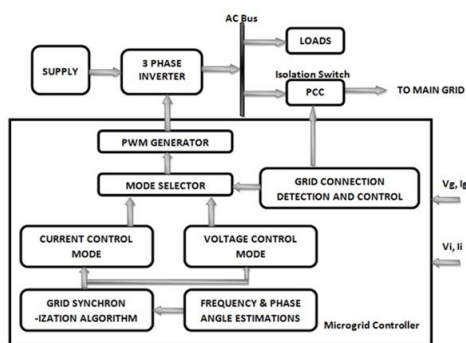

Figure.1. Block diagram representation of Micro grid Controller

Micro grid stability: System stability under the given operational conditions has become an important issue for microgrid operation. For Distributed Generators schemes, the objective of which is to get power from new renewable energy sources, considerations of generator transient stability tend not to be of great significance. If a fault occurs somewhere in the distribution network to depress the network voltage and therefore the Distributed Generator trips, then all that is lost may be a short period of generation. The MGs will tend to over speed and trip on their internal protection. The control scheme in the MGs can then wait for the network condition to be fixed up and restart automatically. In contrast, if a DG is viewed as providing support for the power system, then its transient stability becomes of considerable importance. Both voltage and/or angle stability could be important depending on the circumstances in microgrid (Lasseter, 2002). Stability analysis of the microgrid operation has been investigated by many researchers.

Network Fault and Micro grid Protection: Most of the MG plants use rotating machines and these will contribute to the network fault levels. Both induction and synchronous generators can increase the fault level of the distribution system though their behavior below sustained fault conditions is totally different. The fault level contribution can be reduced by inserting impedance between the generator and also the network by a transformer or reactor (Zeineldin, 2005). In urban areas the existing fault level approaches and therefore the rating of the switchgear will cause increase in fault level that may be a significant implement to the development of DG (Lasseter, 2002).

Grid connected and intentional islanding operations of micro grid:

Current control: Control of the grid side electrical converter utilizes current control loop to direct the grid current. The active and reactive components of the current introduced into the grid are controlled using pulse width modulation (PWM) techniques in the current controlled VSI. A current controller is less sensitive to voltage phase shifts and to distortion in the grid voltage. Also, it is faster in response. On the other hand, the voltage control is sensitive to small phase errors and massive harmonic currents might occur if the grid voltage is distorted. Consequently, the current control is usually recommended within the control of grid connected inverter (Timothy Thacker, 2005).

The main feature of the current control is that it's inborn capacity to restrict the converter output current amid a microgrid fault and in this way gives overcurrent protection to the converter and reduces the fault current contribution of the unit.

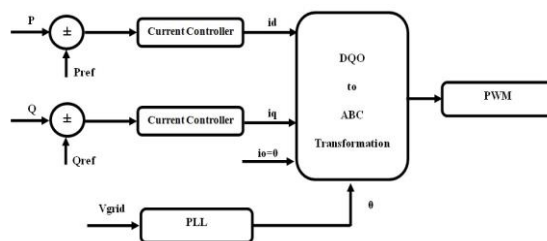

Figure.2. Block diagram representation of Current Control

The current control is most typical strategy utilized for the grid connected mode to control the output voltage and frequency inside the points of confinement. The voltage waveform for the PWM of the VSI will be acquired from the current controlled strategy and can be synchronized with the grid frequency.

For grid-connected operation, the controller is designed to produce a constant current output. A phase locked loop (PLL) is utilized to decide the frequency and angle reference of the PCC. A necessary aspect to consider in grid-connected operation is synchronization with the grid voltage. It is essential that the grid current reference signal is in phase with the grid voltage for unity power factor operation. This grid synchronization can be carried out by utilizing a PLL.

Voltage control: Islanding of micro grid happens because of unplanned occasions the microgrid profile should need a few alterations in order to lessen the imbalance between local load and generation and to diminish the disconnection transient. The current compensation is given to control the voltage regulation.

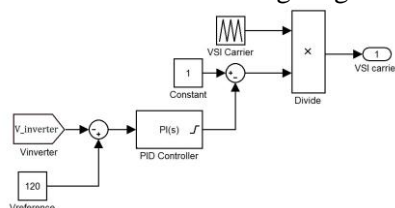

Figure.3. Voltage control during islanded operation

Once islanding occurs, both voltage and frequency deviate from the standard allowable levels. Thus, keeping up both active power and voltage constant throughout standalone functioning of the DG is not possible. Therefore, the control algorithm wants to be modified to account for the new system configuration. In the islanding mode, the DG control has been changed to operate as a voltage controlled VSI as shown in Fig.3. For this situation, the frequency of the modulating signal is set settled at 60 Hz and there's no frequency feedback as within the case of normal operation. The voltage at the PCC is measured and compared with the set value. The error is passed to a PI controller to decide the modulation index value. Three sinusoidal waveforms shifted by 120 degrees are created utilizing the modulation index and are compared with a high frequency triangular waveform to confirm the on-off signals of the inverter switches (Kasem Alaboudy, 2012).

Intentional Islanding Detection Techniques: The primary target of distinguishing an islanding situation is to monitor the DG output parameters and/or system parameters and choose whether or not an islanding circumstance has happened from change in these parameters. Islanding detection techniques will be divided into remote and local techniques and local techniques.

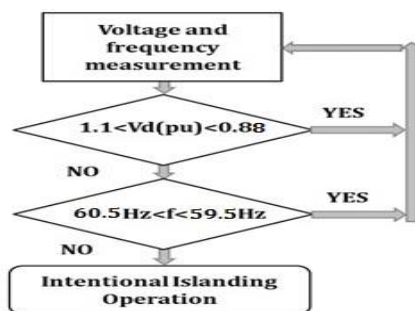

Figure.4. Islanding Detection Algorithm

The islanding detection algorithm utilized here is the voltage unbalance technique. The voltage and the frequency are the parameters utilized here to check whether or not the microgrid is in grid connected or within the islanded mode. The moment at which the microgrid is cut off from the main grid must be identified all together for the DG system to alter between grid connected and intentional islanding modes. This detection is achieved by using a PLL that consists of the Parks transformation, a PI regulator, and an integrator. A PI regulator can be utilized to control this variable, and the yield of this regulator is that the grid frequency. In addition to the frequency, the DQ-PLL is equipped for following the magnitude of its input signals, e.g., the grid voltages. These two parameters, to be specific, frequency and voltage magnitude, are used in the islanding detection algorithm to detect the grid condition. At that point, the algorithm sends a signal that switches the inverter to the reasonable interface control. The algorithm is shown in Fig.4.

While serving as sensible indications for islanding detection, the speedy voltage and frequency variations cause a serious concern: the DG would work out of the permissible voltage or frequency range quickly after islanding happens. For the control to be adaptive, the moment at which islanding happens should be identified such that the inverter switches between the two control modes. The islanding detection algorithm is responsible for causing a signal that switches the inverter to the appropriate interface control. Once islanding is sensed, the DG switches to the voltage control mode. To ensure safe islanded operation of the DG, the output active power of the DG is sensed to assure that it is less than the DG capability. If the load on the island is larger than the DG capability, the DG can become overloaded and a signal is sent to terminate it (Kasem Alaboudy, 2012).

Grid tied Inverter: A grid-tie inverter converts direct current (DC) electricity into alternating current (AC) with a capability to synchronize to interface with a utility line. Its applications are changing DC sources such as solar panels or small wind turbines into AC for tying with the grid. (Timothy Thacker, 2005) Inverters take DC power and invert it to AC power so it will be fed into the electric utility company grid. The grid tie inverter (GTI) should synchronize its frequency with that of the grid employing a local oscillator and limit the voltage to no more than the grid voltage. A high quality modern GTI contains a fixed unity power factor, which means that its output voltage and current are absolutely lined up, and its phase angle is within one degree of the AC power grid. The inverter has an on-board computer that senses the current AC grid wave form, and output a voltage to correspond with the grid. However, supplying reactive power to the grid would possibly be necessary to keep the voltage within the local grid inside allowed limitations.

3. SIMULATION RESULTS

Parameters for Simulation: The performance of the control strategies was evaluated by computer simulation using MATLAB\ Simulink. In the system, the micro sources are represented as a DC sources and main grid as 3 phase voltage source. The point of common coupling (PCC) is represented with a controllable breaker and the loads used are the RL loads.

The system was designed using the following parameters:

DC link voltage	:	400 V
Load capacity	:	8 kW, 1 KVAR
Output phase voltage	:	120 V
Output frequency	:	60 Hz
Switching frequency	:	10 kHz

The system was modeled to supply 8 kW active power and 1 KVAR reactive power during grid connected mode. The micro grid is synchronized with the grid at the time of grid connected mode.

Grid Connected and Islanded Mode: Initially both the breakers are closed i.e., microgrid operates in grid connected mode. The grid voltage is set as 0.85, 1 and 1.2pu for the time duration 0, 0.2 and 0.5 sec respectively. When the grid voltage exceeds the limit the microgrid moves to islanded mode of operation. At that time only critical load is fed. During the grid connected mode the current control is used and during islanded mode voltage control is used.

The controls used are current control during grid connected mode and the voltage control during the islanded mode. The transitions between the two modes are based on the criterion kept for the magnitude and frequency of grid voltage. For maintaining in the grid connected mode, the grid voltage should be within the limit. If the criterion is violated, then system moves to islanded mode until criterion satisfies.

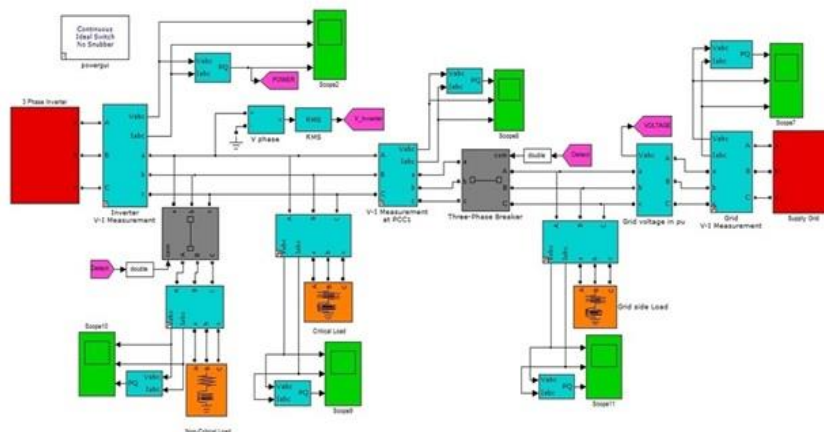

Figure.5. Simulation of current and voltage control block

Inverter output voltage, current and power:

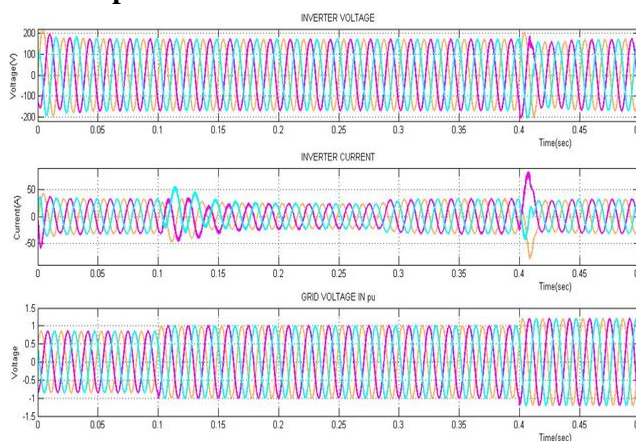

Figure.6. Output waveform of Inverter output voltage and current

In the grid connected mode there will be a power backup from the grid. During the islanded mode power is only supplied from the renewable resources in the microgrid. Here in the simulation from time 0 to 0.1 sec and from 0.4 to 0.5 sec the system is the islanded mode as the grid voltage is not in the specified limit. From 0.1 to 0.4 sec the system is in grid connected mode as the grid voltage is within the limit. The inverter supplies 8 kW active and the 1 KVAR during both the grid connected mode and the islanded mode of operation.

Here the grid voltage is set as 0.85 p.u, for, 102 V for 0 to 0.1 sec, 1 p.u, for, 120 V for 0.1-0.4 sec and 1.2 p.u, for 144 V for 0.4-0.5 sec. The microgrid operates in the islanded mode in the first and the third interval as the voltage are no in the specific limit. The specified limit for the grid voltage is $0.88 < V \text{ (p.u)} < 1.1$ and grid frequency is $59.5 < \text{Freq} < 60.5$.

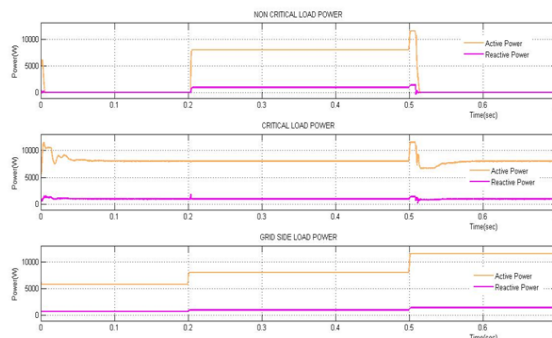

Figure.7. Output waveform of non-critical load power, critical load power and grid side load power

The critical load is of the power rating, active power 8 kW and reactive power 1 KVAR. The critical load is maintained undisturbed during both mode of operation.

The non-critical load is of the power rating, active power 8 kW and reactive power 1 KVAR. This load get power only during grid connected mode. During islanded mode of operation, for maintaining stable power to the critical load this load is shedded from the line. From the graph we can observe that the non-critical load get power only during the period 0.1 to 0.4 sec, i.e. in the grid connected mode. During the remaining time this load is isolated from the system using a breaker.

The grid side load is of the power rating, active power 8 kW and reactive power 1 KVAR. This load is fed from the main grid only. According to the variation in the grid side this load also gets affected.

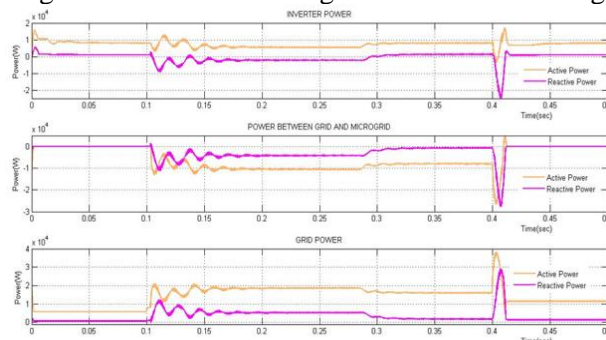

Figure.8. Output waveform of inverter power, power between grid and micro grid and grid power

In grid connected mode, the inverter output provides 8 kW active power and 1 KVAR reactive power. The power drawn from the main grid is 16 kW active power and 2 KVAR reactive power. The power supply from main grid to micro grid is 8 kW active power and 1 KVAR reactive power. During islanded mode, the inverter output provides 8 kW active power and 1 KVAR reactive power to supply the critical load. No power is supplied from main grid to the microgrid. The non-critical load is shedded from the system during this period.

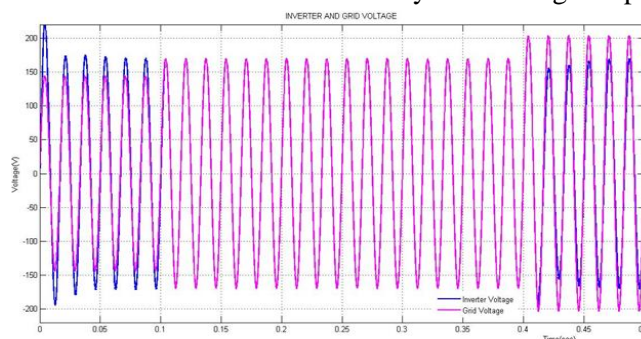

Figure.9. Output waveform of inverter voltage and grid voltage

In the grid connected mode, the grid side voltage and the microgrid side voltage will be synchronized. From the figure we can observe that both the grid and the inverter output voltages are in phase, magnitude are same, frequency are same and they are in the same sequence. During 0.1 to 0.4 sec both the inverter voltage and the grid peak voltage is 169.7 V and the frequency is 60 Hz. In the islanded mode, the grid side voltage and the microgrid side voltage will not be synchronized. From the 0 to 0.1 sec the grid voltage is less than the inverter voltage. Here for the simulation only variation to the voltage of the grid is shown by keeping the grid frequency constant at 60 Hz.

Comparison of grid parameters:

Table.1. Result analysis during different voltage and frequency

Grid Parameters	Mode of operation	Control Implemented	Power flow from grid to MG	Time taken to settle down the power
Voltage below 0.88pu	Islanded mode	Voltage control	Nil	0.05 sec
Voltage between 0.88 & 1.1pu	Grid connected Mode	Current Control	8kW 1kVAR	0.2 sec
Voltage above 1.1pu	Islanded mode	Voltage control	Nil	0.05 sec
Frequency below 59.5Hz	Islanded mode	Voltage control	Nil	0.05 sec
Frequency between 59.5Hz & 60.5Hz	Grid connected mode	Current Control	8kW 1kVAR	0.2 sec
Frequency above 60.5Hz	Islanded mode	Voltage control	Nil	0.05 sec

From the simulation results it is observed that microgrid operates in two mode depending on the grid voltage and frequency. During the grid connected mode the current control is obtained to maintain the parameters and the grid gives back up to the microgrid to serve all the loads. During the islanded mode the voltage control is obtained to maintain the parameters. No backup is given from the grid to the microgrid.

So to maintain the critical loads stable non critical loads are shedded. During the grid connected mode it takes around 0.2 sec to settle down and during the islanding mode it takes around 0.05 sec to settle down.

4. CONCLUSION

The control, islanding recognition, and enclosure algorithms have been accomplished for the operation of grid-connected and purposeful islanding DGs. A controller was created one for grid-connected operation and the alternative for purposeful islanding operation. An islanding-detection algorithm, which is used for switching between the two controllers, was done. The enclosure algorithm causes the DG to resynchronize itself with the grid. Also, it is demonstrated that the control schemes is capable of maintaining the voltages and currents among permissible levels throughout grid connected and islanding operation modes. During islanded mode load shedding technique is implemented to sustain the critical load with great quality power supply.

REFERENCES

- Ahmed Abdalrahman, Abdalhalim Zekry, Ahmed Alshazly, Simulation and Implementation of Grid-connected Inverters, *International Journal of Computer Applications*, 60 (4), 2012.
- Hartono B.S, Budiyanto Y, Setiabudy R, Review of microgrid technology, *IEEE International Conference on QiR (Quality in Research)*, 2013, 127 132.
- Irvin J, Balaguer, Qin Lei, Shuitao Yang, Uthane Supatti, and Fang Zheng Peng, Control for Grid Connected and Intentional Islanding Operations of Distributed Power Generation, *IEEE Transactions On Industrial Electronics*, 58 (1), 2011, 147 - 157.
- Kasem Alaboudy A.H, Kirtley J.L, Microgrid Stability Characterization Subsequent to Fault- Triggered Islanding Incidents, *IEEE Transactions on Power Delivery*, 27, 2012, 658 - 669.
- Lasseter R.H, Micro Grids, *Power Engineering Society Winter Meeting, IEEE*, 1, 2002, 305 - 308.
- Lopes J, Moreira C and Madureira A, Designing control strategies for microgrids islanded operation, *IEEE Transactions*, 21 (2), 2009, 916 - 924.
- Marinescu C, Serban I, Robust frequency control for a wind/hydro autonomous microgrid, *PowerTech, IEEE Trondheim*, 2011, 1 - 6.
- Micallef A, Apap M, Spiteri-Staines C, Guerrero J.M, Secondary control for reactive power sharing in droop-controlled islanded microgrids, *Industrial Electronics (ISIE), IEEE International Symposium*, 2012, 1627 - 1633.
- Timothy Thacker, Fred Wang, and Dushan Boroyevich, Islanding Control of a Distributed Generation Units Power Conversion System to the Electric Utility Grid, *Power Electronics Specialists Conference, PESC '05, IEEE 36th*, 2005, 210-216.
- Vandoorn L, Meersman B, Analogy Between Conventional Grid Control and Islanded Microgrid Control Based on a Global DC-Link Voltage Droop, *IEEE Transactions on Power Delivery*, 27 (3), 2012, 1405 - 1414.
- Zeineldin H, El-Saadany E.F, Salama M.M.A, Intentional islanding of distributed generation, *IEEE Power Engineering Society General Meeting*, 2 (12), 2005, 1496 - 1502.