



Sun Tracking and Control Design for PV Solar Energy System

Original Article

Sheher Bano¹, Syed Irtiza Ali Shah¹, Adeel Ahmed Abro¹, Umbreen Tariq¹
¹Air University, Islamabad.

* Correspondence: Adeel Ahmed Abro, ahmedadeel8271@gmail.com

Citation | U. T. Sheher Bano, Syed Irtiza Ali Shah, Adeel Ahmed Abro, “Sun Tracking and Control Design for PV Solar Energy System,” *Int. J. Innov. Sci. Technol.*, vol. Special Is, pp. 77–93, 2022.

Received | June 06, 2022; **Revised** | June 22, 2022; **Accepted** | June 26, 2022; **Published** | June 30, 2022

In this modern era of the rapid increase in population, a high rise in technology, and a large number of machinery installed, fuel demand has increased significantly. Non-renewable energies contribute a lot to producing energy worldwide, and that's why they are decreasing at an alarming rate. As an alternative, renewable energies have a high potential to solve this upcoming issue. In this paper, sunlight is utilized for the location of Islamabad, and an active solar tracker is designed. The objective is to develop a cost-effective system with low maintenance requirements. The tracking mechanism is modeled by two sensors, LDR and PV sensor. LDR sensor generates high resistance when light is incident on them, thus reducing the voltage production. PV sensors produce a voltage when sunlight is incident on them, and a voltage drop occurs if a shadow occurs. A thin plate between two LDR sensors or two PV sensors will cast a shadow according to the sun's position. It will create a voltage difference between the two sides, thus causing the system to track the sun. For smooth movement, a servomotor is an effective choice. The system is integrated with a microcontroller for a feedback system of output; Arduino Uno will regulate the uniform and accurate movement of the system. The research on azimuth and elevation angles for the location of an installment is also included in this paper. Different tests are performed for comparative study for both sensors to have performance analysis.

Keywords: Renewable Energy; Solar Energy; Tracking mechanism; LDR and Solar panels; Arduino UNO

Acknowledgment.

We acknowledge the support of the Pakistan Council of Renewable Energy Technologies to have provided us access to an actual automatic sun tracking solar energy system we later implemented the work done as part of this research. We also acknowledge the administrative and technical support provided by the

Institute of Avionics and Astronautics, Air University Pakistan.

Conflict of interest:

The author(s) declare that the publication of this article has no conflict of interest.

Author's Contribution. All of my co-authors contributed to this research in the form of data collection write-up and improvement.

Project details.

This research was conducted as a part of a Final Year Project for BE-Mechanical Engineering for the undergrad level. The project number is seven the and cost of the project was twenty thousand rupees. The project was completed on May 01, 2022.



Introduction

Over the past few decades, the world has had a major energy crisis. The situation is more intense in third-world countries because of a severe difference between energy production and demand. With this ever-increasing demand, the non-renewable resources of energy seem not to be sufficient enough. To meet the energy requirement, many researchers suggested that renewable sources might be the alternative to the major energy resources of today.

Renewable resources are of different kinds, including Solar, Wind, Hydro, Geothermal, Biomass, etc. Solar energy is one of them the most eco-friendly mean of energy production. If we consider the phenomenon of absorption and diffraction, the total flux reaching earth is 1.08×10^8 GW and the total energy is 3,400,000 EJ annually. This value is nearly seven to eight thousand times of energy requirement. If this energy is used effectively and productively solar energy has the potential to solve the current issues of energy crisis.

Solar Cells

A solar panel is a combination of photovoltaic cells along with protective glass and a frame of plastic or metal. The most effective types of solar cells are Monocrystalline, Polycrystalline, and amorphous because of their overall performance and wide applicability. A study conducted shows that monocrystalline has better energy production than the amorphous type, following can be depicted in the Figure.1 too in a graphical manner:

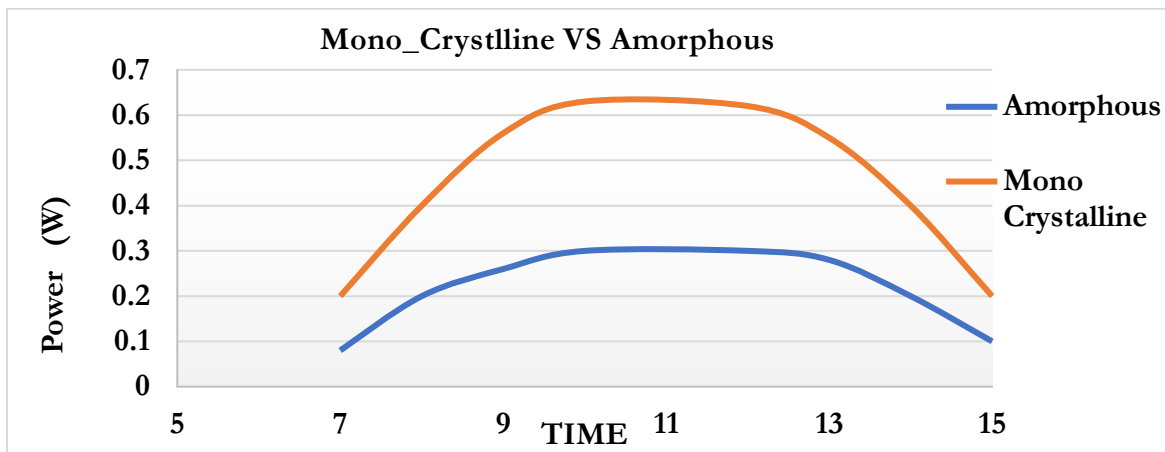

Figure 1. Power generation comparison of Monocrystalline vs Amorphous type [1]

Another study conducted shows that monocrystalline works more efficiently with polycrystalline types of solar cells when there is no drastic change in average solar radiations. This shows cell type of solar cell that can be used among these three for uniform solar flux is mono-crystalline. Figure. 2 shows the comparison between monocrystalline and polycrystalline cells.

Solar Tracking

The efficiency of a solar panel that is fixed on a frame lies in the range of 15-25% only. On the contrary, the solar panel accompanied by solar trackers can have an efficiency of about 32-40% [2]. Now for the solar tracking systems, we have two types:

Single Axis Tracking

This system follows only one trajectory, which is majorly from East to West. The single-axis tracking can have an efficiency of about 27- 32%. There are different types of single-axis solar trackers, one with single axis tracking in a horizontal plane or tracking with an inclined panel to increase efficiency, other is single axis tracking in the perpendicular plane with either flat or inclined panels.

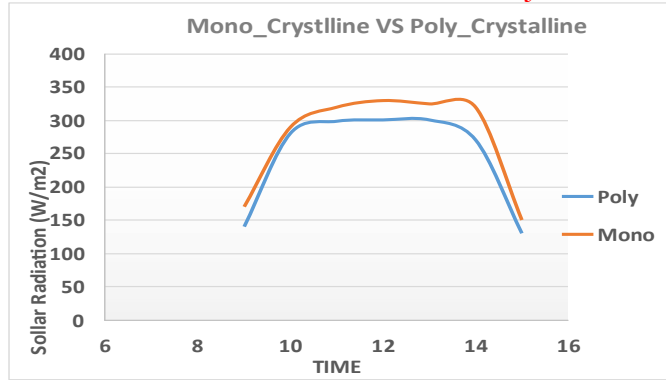

Figure 2. Hourly measured solar radiation by Monocrystalline vs Polycrystalline solar cells [1]

Dual Axis Solar Tracking

Even though a single axis tracker system increases the efficiency of solar cells, we still have the potential to increase the efficiency even more. The sun changes its path season-wise, Figure. 4, so if a solar panel can track this changing trajectory too along with east to west motion, its efficiency can increase. A dual-axis solar tracker is used for this purpose. A dual axis system can increase the efficiency of the solar tracker to about 35-40% [3].

Solar Tracking via Micro-Controller

A solar tracker system incorporated micro-controller can have high performance and efficiency. Micro-Controller can be of two types: Close and open, the weather gets feedback from the sensor that the solar panel has reached the microcontroller or not. The opened-type microcontroller doesn't have such a feedback mechanism.

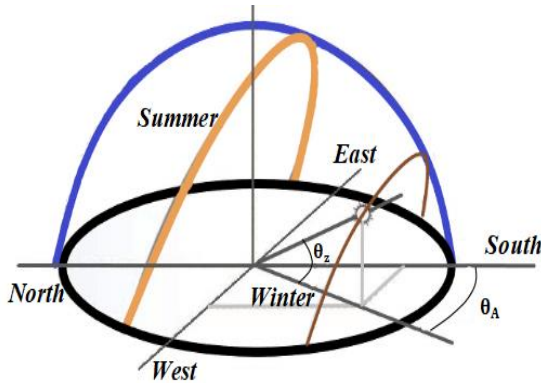

Figure 3. Proposed trajectories change for generic variation in sun path through summer and winter [4]

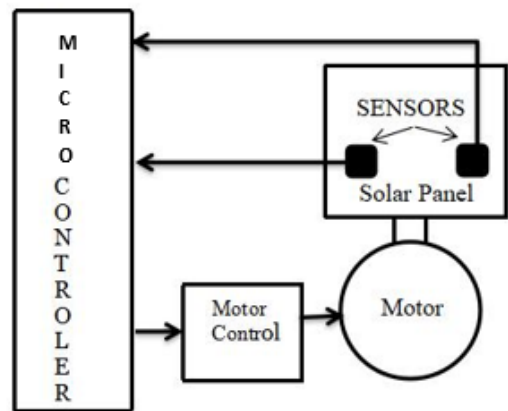

Figure 4. Proposed conceptual control system for solar track

This paper aims to increase the performance of solar panels by tracking the sun. Solar panels have to be designed to follow the sun. In this paper, the tracking mechanism is performed by two different options. Firstly, through LDRs to align the system with the sun, secondly through solar panels as the sensor.

A microcontroller is installed with the system to regulate the voltage and get the desired result accurately. A comparison is drawn at the end between both means. The scope is to devise a cost-effective sign with less maintenance and simple configuration. This is because of all the complexities added to the system to increase it and s performance and reduce the life span of solar panels. So, the goal is to design an effective system with a simple design. The system designed is an indigenous control system with a new sensor and actuation mechanisms m. Moreover, this is solely based on previous research. Also, this control system is implementable on physical solar panel assemblies.

Material and Methods.

A dual-axis solar tracker system is designed. For simplicity, the elevation angle is controlled manually while the azimuth angle is tracked by rotating the system. It is achieved by converting the fixed frame into a rotating one with the aid of a servomotor. The system will rotate freely to become aligned to the sun via a sensing mechanism.

This sensing mechanism is firstly drawn from two LDR systems placed left and right of the system. The Light Dependent Resistor (LDR) will sense and track the sun thus moving the system accordingly. Between the LDRs, there is a thin plate placed. If the sun position is not right at the top, it will cast a shadow on either of the LDRs, thus adjusting the system. Best performance is possible when the intensity of sun rays is the same on both LDRs.

For the next model, instead of LDRs, two PV sensors of 10V are used. Between these PV sensors, a thin plate is placed. It will cast a shadow on either of them; according to the sun's position. The shadow will reduce the intensity of sun rays, thus reducing the voltage production, this voltage difference will align the system to the sun. Using solar panels will provide a comparative study for efficiency and performance.

The microcontroller used in this paper is Arduino UNO. Arduino is known best for its simplicity, flexibility, and ease of utilization. However, Arduino has an upper limitation on voltage, 5V. To integrate the second system; with the differential PV sensor, a buck converter is used to reduce the 10 V to 5V.

Calculation of Solar Panel Angle

Solar panel orientation to the sun is of major concern. The angle of the solar panel for the sun depends upon the area in which the solar panel is installed. To maximize the absorption of solar energy solar panels should directly face the sun. To gain maximum solar energy solar panels should be vertical during winter and more tilted during summer.

Since the sun is always in motion so its azimuth and elevation angle are changing continuously. The prime location of our concern is Islamabad having longitude and latitude of 33.6844° N, 73.0479° E. To determine azimuth and elevation angle, Sun Rise, and Sunset designed two models utilizing both of these sensors, side by side, to have comparative results and to judge the performance.

Novelty Statement

Many research work is available on tracking solar systems using LDR as a sensor, using two or four LDRs. Similarly, many differential PV sensors are also available. In this study, we have designed two models utilizing both of these sensors, side by side, to have comparative results and to judge the performance.

The first model that was developed is sun tracking with an LDR sensor that operates via Micro-Servomotor. In this model, LDR sensors are used as a sensing element with a divider between two LDR. The divider serves the purpose of shading elements on the sensor. When the sun is moving towards the East there is a shade on LDR that is on the west side, as a result, it gives the digital value of "0" while the other gives the value of "1". Our system is programmed in such a way that the LDR sensor gives the digital value of "1" until both LDR has a digital value of "1". The servomotor motor stops when both LDR has either value of "1" or "0". This model was developed to understand the basis of Sun Tracking.

Table 1. Monthly change for azimuth angle/elevation angle[5]

Year	Month	Date	Time	Azimuth Angle/Elevation Angle	Sun Rise / Sunset Time
2022	Jan	25	13:00	-168.40° / 36.55°	07:09 / 17:32
	Feb	25		-166.19° / 46.27°	06:42 / 18:01
	Mar	25		-158.97° / 56.38°	06:05 / 18:23
	Apr	25		-145.71° / 66.09°	05:26 / 18:46
	May	25		-132.56° / 72.33°	05:01 / 19:08
	Jun	25		-130.35° / 75.06°	04:59 / 19:22
	Jul	25		-141.46° / 72.72°	05:15 / 19:14
	Aug	25		-150.60° / 64.38°	05:37 / 18:43
	Sept	25		-154.42° / 52.63°	05:57 / 18:01
	Oct	25		-157.31° / 41.39°	06:20 / 17:22
	Nov	25		-161.48° / 33.38°	06:48 / 17:00
	Dec	25		-165.90° / 31.61°	07:10 / 17:05

Material and Methods

Solar Tracking System with LDR expressed in Figure 5

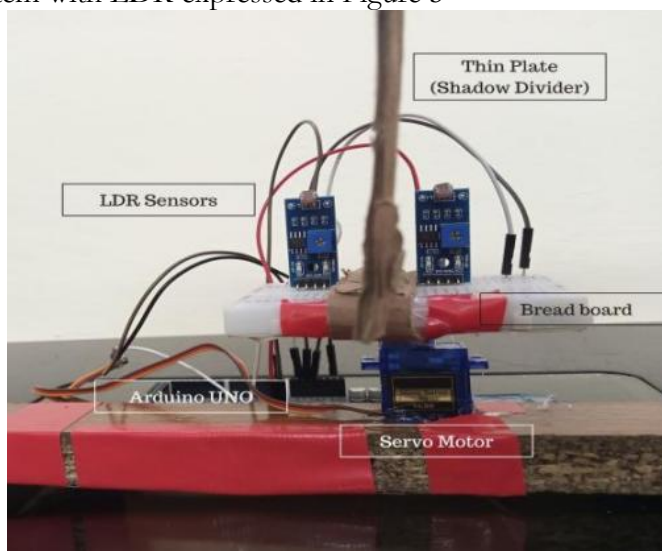

Figure 5. Proposed system setup with LDR Sensor

Components

Arduino UNO

Microcontrollers are small computers capable of doing simple tasks with efficiency. These small circuit boards are so designed that they can be powered by a small battery. And they can be powered for days using small cells.

Microcontrollers are integrated circuits. These circuits use logic provided in their programming to do simple tasks. Arduino is a company based in Italy that is responsible for making circuits that make the usage of microcontroller IC easy and time-saving. These boards are called Arduino. Another positive factor about Arduino is that they are open source. Hence, they are used in a wide variety of market products [6].

The Arduino is programmed using special software in which the loops are applied. These loops define the path of the Arduino working. These loops are then implemented in the microcontroller and then actuate the system accordingly. The circuit can be just a simple circuit or multiple circuits can be operated using a single Arduino.

Furthermore, Arduino is capable of reading data from sensors that are presented as INPUTS. In a complete system sensors and actuators are coupled up to make a complete circuit and complete a task.

Hardware

There are many different Arduino boards available, but only the Arduino UNO will be examined. The Arduino UNO is a microcontroller board based on the ATmega328, an Atmel 8-bit AVR RISC-based microcontroller with high performance. The device runs on a voltage range of 1.8 to 5.5 volts.

The component of Arduino are as follows:

TABLE 2. DESCRIPTION OF ARDUINO COMPONENTS [7]

Components	Description
USB Plug	To Power Arduino board To upload a program to the microcontroller
External Power Source	To power the board (9 to 12 volts)
Reset Button	To resets the Arduino
Microcontroller	To acquire data and then sends it to a particular circuit.
Analog Pins	AO to A5
Digital I/O Pins	Output pins 2 to 3
In-Circuit Programmer	For Programming software by using "TX" output and "RX" input.
Ground pins	Digital and Analogue
Power Pin	3.3 and 5V

Software

The Arduino ecosystem is free and simple to use. It is written in Java and is based on free source tools such as Processing. It has a code editor with various features and also the sort out and submit programs to the board. A "sketch" is a program developed for Arduino by using C or C++ language [6].

The Arduino IDE (integrated development environment) Figure 6 incorporates a software library and has a command area, text area, and message window area. The Arduino IDE is available for Windows as well as MAC and Linux. This makes it the easiest to use almost and most accessible software for Arduino programming [7].



Figure 6. The picture was taken on the white background of Arduino Uno Rev 3 used as a controller

Servo Motor

A servo motor is an actuator (rotary or linear) that is capable of controlling position (angular or linear), velocity, and acceleration precisely. It comprises a motor that accompanies a position feedback sensor.

"Servo motor" refers to a particular type of actuator (linear or rotary). It is a servo mechanism, which indicates that the motor's motion is continuously observed and controlled [8].

Working

A servo motor presented in figure 7, is an electromechanical device that employs voltage and current to generate velocity and torque. A servo motor is utilized in closed-loop control, to provide velocity and torque as directed by a servo controller, which closes the loop via a feedback device. This device then sends data to the controller as a result of commanded parameters motor movement is modified. The control cable is used to provide a variable width electrical pulse or pulse width modulation (PWM) to the servos. A rotation of 18degreeesee (90

degrees in either direction) is possible using a motor. The motor stop when at a point where the potential of rotation is equal for both direction (clockwise and counterclockwise). The rotor turns into the desired position with the help of PWM provided to the motor, which is depending on the duration of the pulse sent over the control line [8].



Figure 7. The picture was taken on the white background of Servomotor SG90 used for actuation

Light Dependent Resistor (LDR)

The LDR Module s shown in Figure 8, is a sensor-based module that can be coupled up with the Arduino. The LDR module mainly consists of an LDR sensor which is further attached to a circuit. The LDR module works on a very simple principle. When light is incident on the LDR module, the electrical resistance drops. Consequently, the voltage increases. This voltage can be fed into the Arduino Microcontroller both digitally and analogically. Digitally the output would be 1 when light hits the sensor and 0 when it is not incident

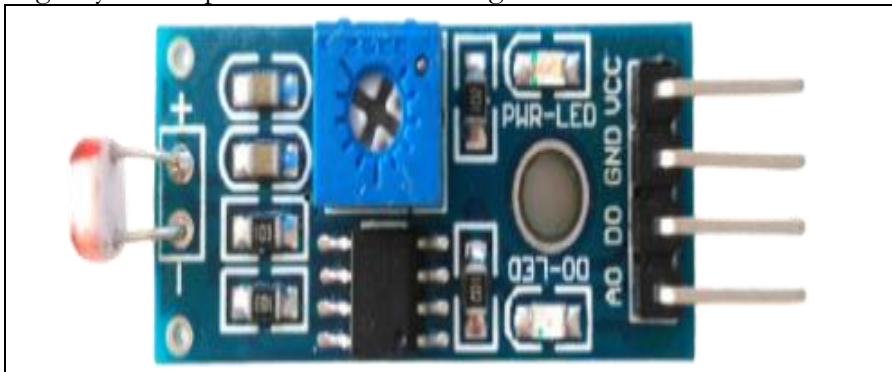

Figure 8. The picture was taken on the white background of LDR Module LM 393 used for light sensing

Bread Board

A bread Board is a base for constructing electronic circuits and electronic prototyping. The breadboard has certain sets of connections already made on it. This allows easy testing and prototyping of electronics. Moreover, using a breadboard does not require any kind of soldering. All the soldering and connection processes are already done.

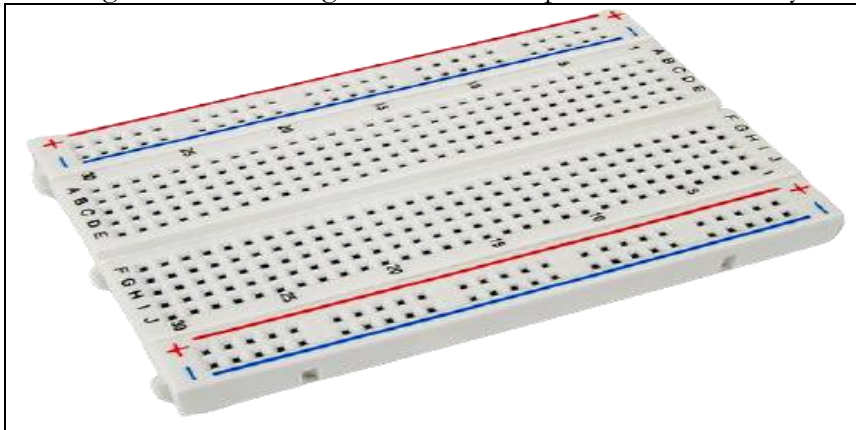

Figure 9. The picture was taken on the white background of Bread Board used for the implementation of circuit

Flow Diagram of System

Figure. 10 shows the algorithm the system will follow;

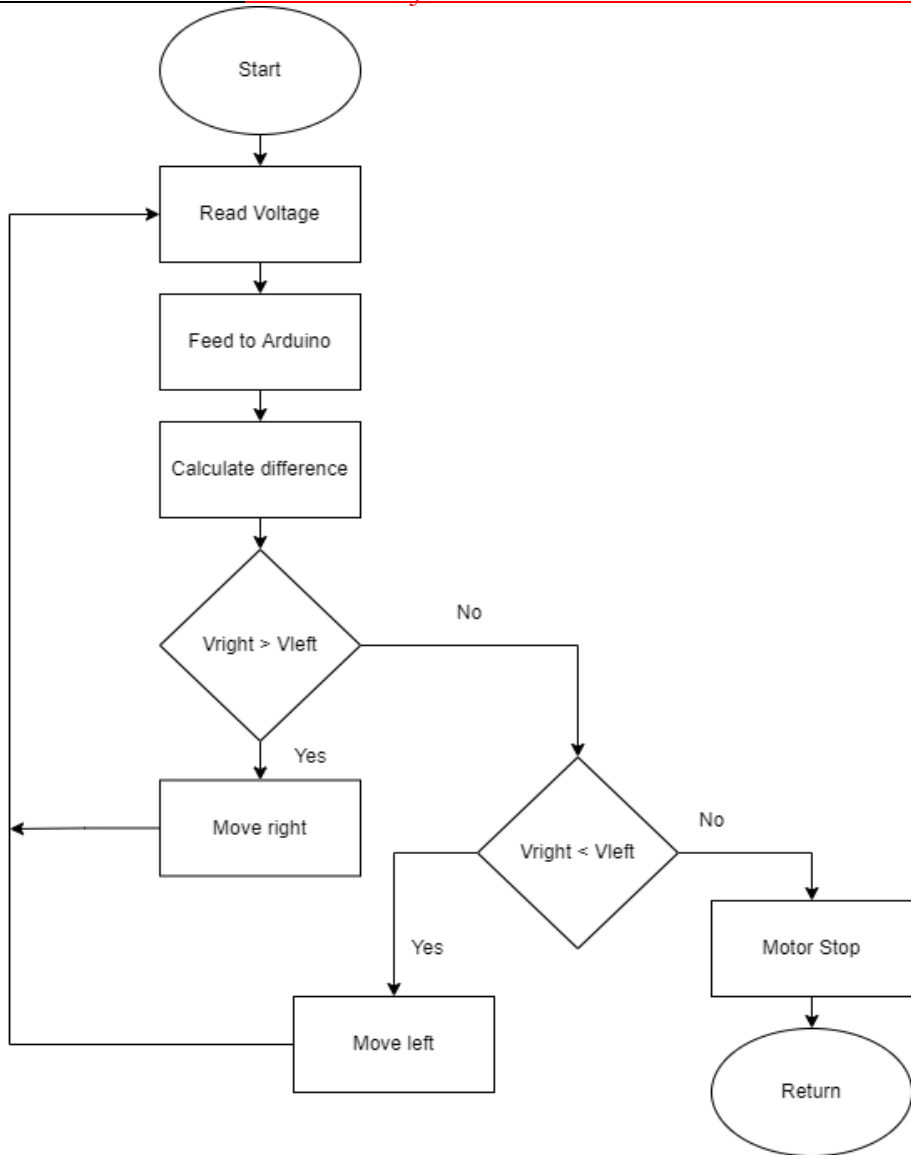

Figure 10. Proposed flow diagram of solar tracking system with LDRs Sensor
Sun Tracking with Differential PV sensor

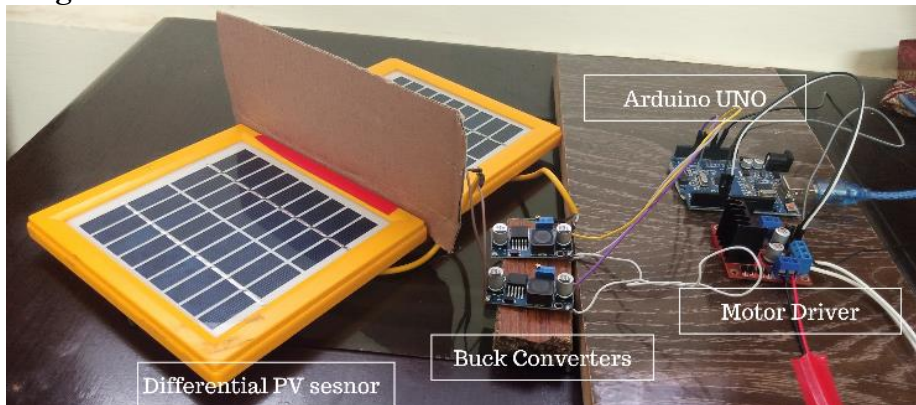

Figure 11. A picture was taken of the lab mockup based on differential PV sensors

The Second model that was developed is comparable to the original system on which the controller needs to be operated. In this system, solar panels serve the purpose of sensing

elements with a divider (voltage divider) in between[9]. The motor driver control the direction of rotation i.e., clockwise (towards east) anticlockwise (towards west), and Speed.

The power to drive the system is taken from a 12 V dc motor. The divider serves as a shading element. When the sun is moving toward the east the solar panel on the east side gets a voltage of 5 V while the other panel on the west side due to shading ga etc a voltage less than 5V as a result of this system moving toward the east. The motor stops when either each sensor has a voltage less than 5V or the voltage of both sensors is 5V.

Components

Motor Driver

L298N Motor Driver Module is a high-performance motor driver used for Stepper and DC Motors. It is used for controlling the direction of rotation and also the speed the of DC motor. For this purpose, the following methods are used:

PWM: controlling speed.

H-Bridge: controlling the direction of rotation.

PWM (Pulse Width Modulation)

PWM (pulse width modulation) is a method that is common for payload speed control by changing the DC motor’s voltage for managing speed. Input voltage average value is adjusted by transmitting on and off pulses. The average value of voltage depends upon the Duty cycle (proportional to the pulse’s width [10]).

H-Bridge

H Bridge is utilized to control spinning direction by changing DC’s motor polarity.

The motor's spinning direction changes when the voltage applied is reversed when both particular switches close [10].

TABLE I. L298N MODULE PINOUT CONFIGURATION[11]

Components	Functions
L298N Motor Driver IC	Has a heat sink and can control two motorist or independently
Power Supply	Pitch Screw Convertor to power motor driver
IN1 and IN2	Input pins for Motor A. Motor A's spinning direction are controlled by this device.
IN3 and IN3	Input pins for Motor B. Motor B's spinning direction are controlled by this device.
ENA	PWM signal for Motor A is enabled.
END	PWM signal for Motor B is enabled.
OUT1 and OUT2	For Motor A
OUT3 and OUT4	For Motor B
12V	12V from a DC power supply
5V	Provides power to the L298N IC's switching logic circuits.
GND	Ground Pin

Voltage Drop of L298N

The L298N motor driver encounters a 2V voltage drop which is due ta o voltage drop across H Bridge transistors. the motor is not able to get the desired amount of voltage. To cater to this problem motor should supply voltage higher than desired.

Buck Converter

A buck converter is a device that is used that is a Step-down voltage adjuster. It is a DC-to-DC converter that consists of switches, a transistor inductor-capacitor, and a diode. In a boost converter, the position of the transistor and inductor is switched. Normally, power electronics switches are used. The switch can be turned on and off with the aid of a PWM signal [12]

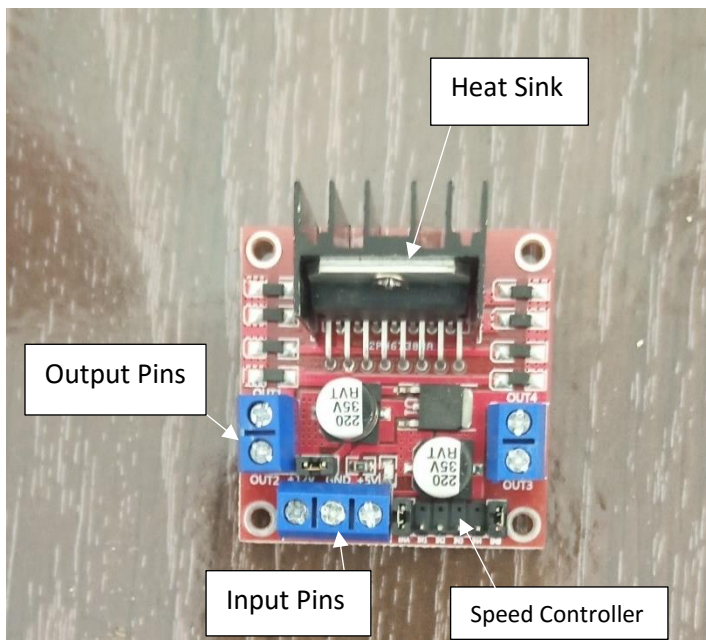

Figure 12. Picture taken on the white background of Motor Driver used for motor speed and direction control

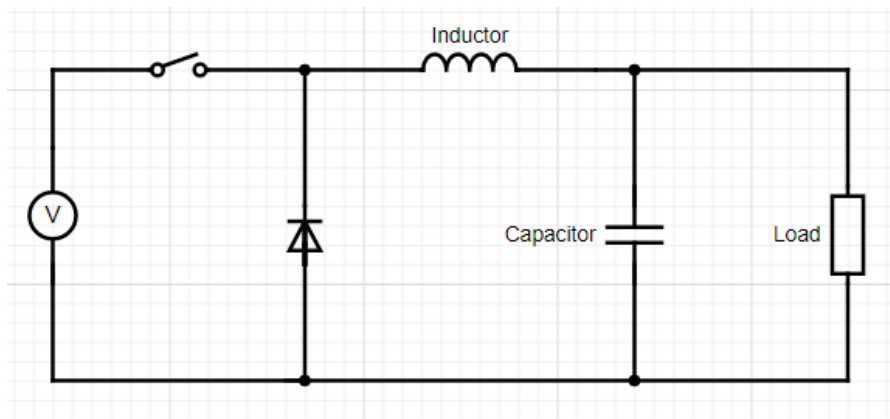

Figure 13. Schematic of Buck Converter [11]

Working

A buck converter working is as follows STEP 1: Firstly, The switch is triggered which allows electricity to pass through the switch and deliver to the output capacitor. Charging current is limited by the inductor and also capacitor charging is not instantly as a result capacitor will not get an entire voltage

STEP 2: Now the switch is turned off. The voltage across the inductor is generated, as the inductor's current is not changing abruptly. A diode is used when the switch is turned off allowing voltage to charge the capacitor and power load. As a result output current is sustained [12].

The cycle is repeated to get a continuous stream of output.



Figure 14. Buck Converter used for step down voltage output [12]

PV Sensor

A solar panel has a combination of PV cells arranged on a frame. Photo Voltaic cells get energy from the sun's radiations and produce voltages. The solar panel used generates 5V when accompanied by a buck converter.

Flow Diagram of system

Figure. 15. shows the algorithm the system will follow;

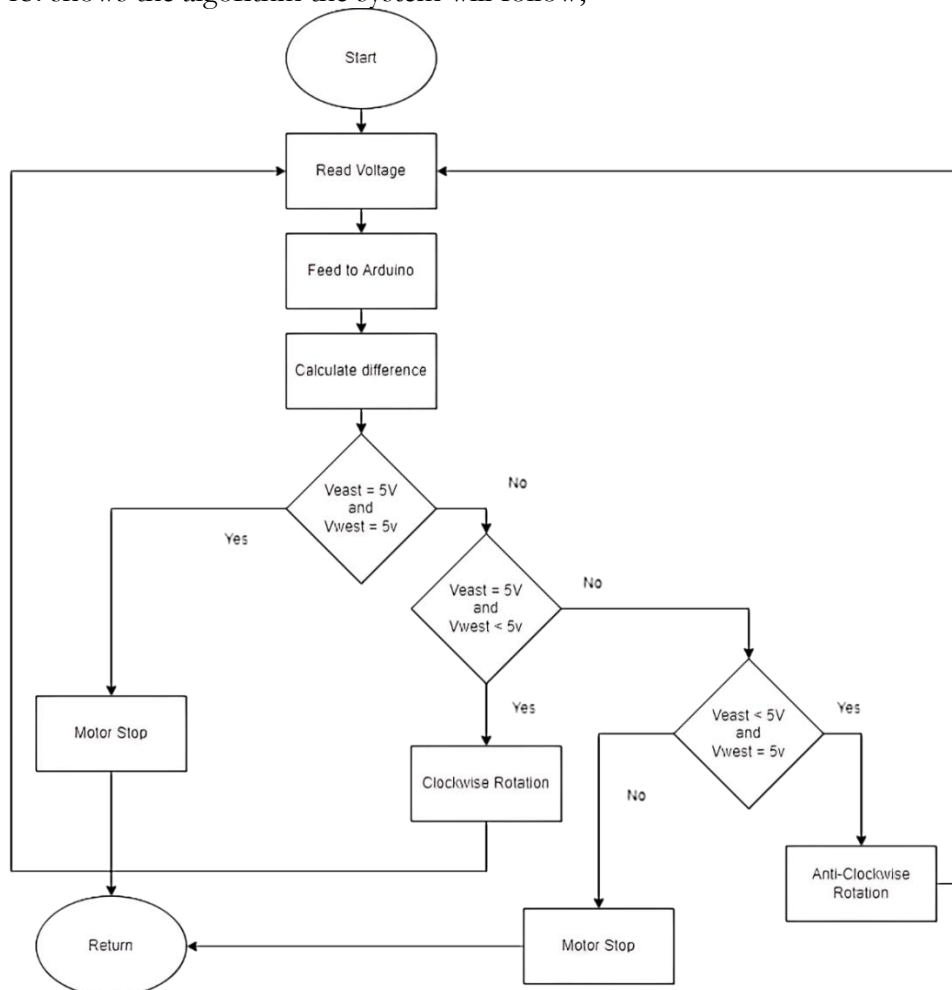

Figure 15. Flow Diagram of the proposed system with differential PV sensors

Result and Discussion

The most important part of the designing process is the testing part. It reassures the validity of the proposed design. The two proposed models were tested separately, and the results would give the measure of usability of the system.

1st Lab Mockup

The first lab mockup was based on LDR. The actuator used was the Micro servo motor which is considered ideal for model testing.

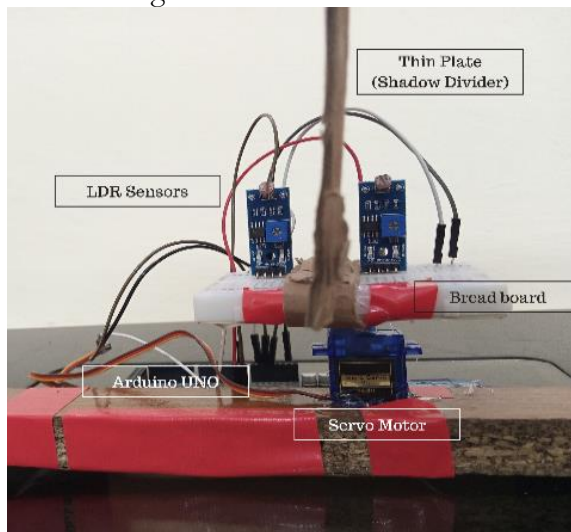

Figure 16. 1st lab mockup based on LDR and Micro servomotor

The above system was tested under an artificial light source and then under the sun. Both the results would validate the system’s performance.

Test Assembly

The testing of the system requires a protractor which would be used to measure the angle. For that purpose, an improvised protractor was made to assist with angle measurement.

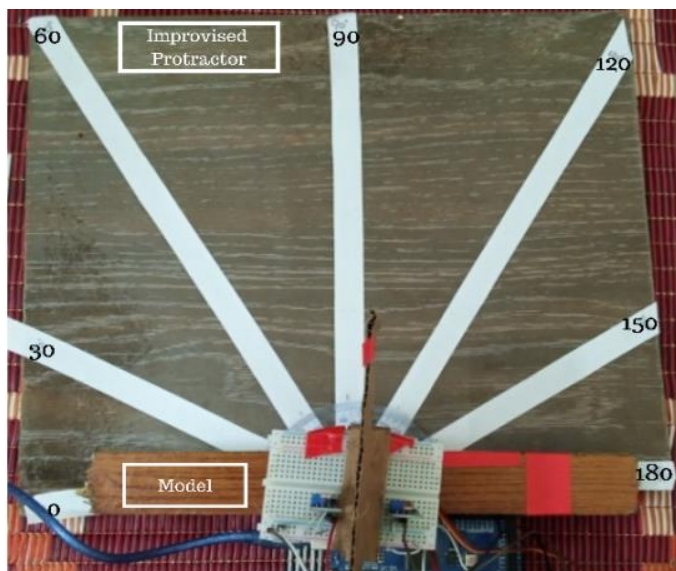

Figure 17. Testing Assembly for 1st model

The above snapshots show the test configuration. The light source will be placed at an elevation of 45 degrees. The angle of 45 degrees was done using conventional trigonometric techniques. The base and the height of the light source are kept equal. This leads to the division being equal to 1 and its inverse tan to 45 degrees.

The light source was placed at each of the 7 points and the corresponding angle of the tracker system was measured. All the results were tabulated in a table.

TABLE 3 TRACKER POSITION W.R.T LIGHT POSITION

Position of the light source	Light source azimuth Angle	Tracker azimuth angle
1	0	20
2	30	33
3	60	60
4	90	80
5	120	120
6	150	150
7	180	170

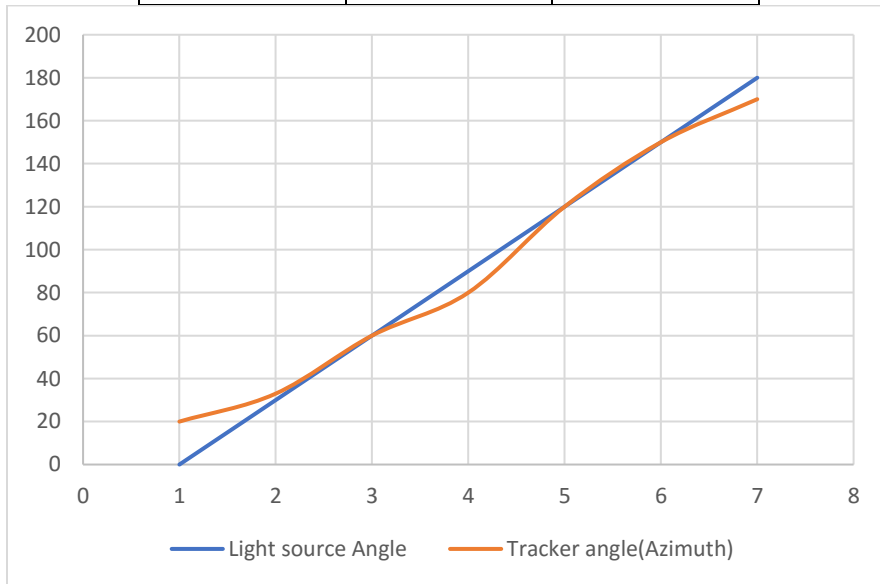

Figure 18. Tracker azimuth angle w.r.t Light source azimuth angle

It can be seen that the angle of the tracker is lagging the light source. The reason is the shading element. A bigger-sized shading element would mean an increase in the efficiency of tracking.

The LDR-based system, while using a digital input, was unable to track the sun. The reason is the scattered light coming from the sun. For the LDR the light source must have less scattered light. Whereas, in the case of the sun, the light is scattered in all directions making it difficult for the LDR to detect the position of the sun correctly.

2nd Lab Mockup

The second lab mockup is designed to actuate the azimuth axis of a real system. For this, a DC motor would be used. The motor will be rotated both in the clockwise and the anticlockwise direction. This change in polarity will accomplish the eastward and westward motion of the solar panel system.

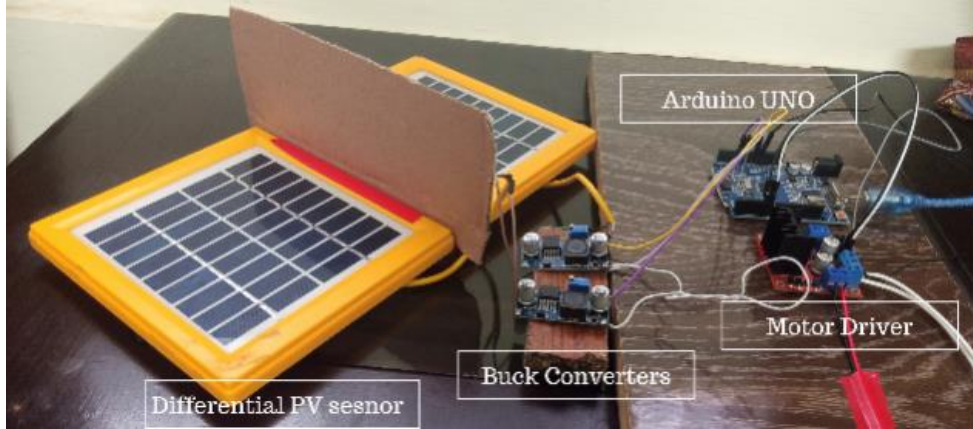

Figure 19. 2nd Lab mockup proposed for testing

The system consists of solar panels as sensors. This will lead to the assessment of the position of the sun. When one of the panels is incident with light, the code is so designed that the motor will rotate clockwise and anticlockwise according to the incident side.

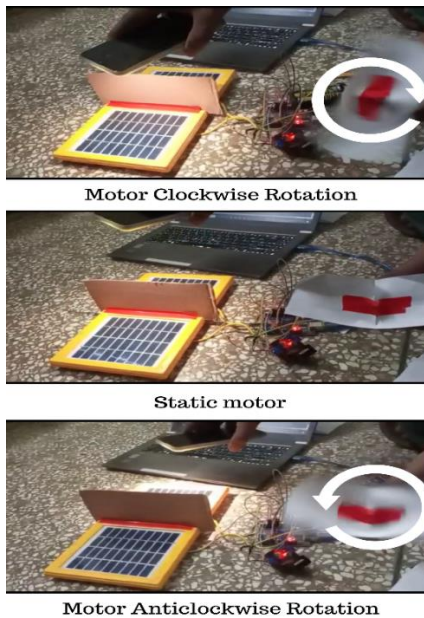

Figure 20. Rotation of the motor w.r.t to light incident

It can be seen in the snapshots that the motor rotates in the clockwise as well as in the anticlockwise direction depending upon the side of the solar panel getting light.

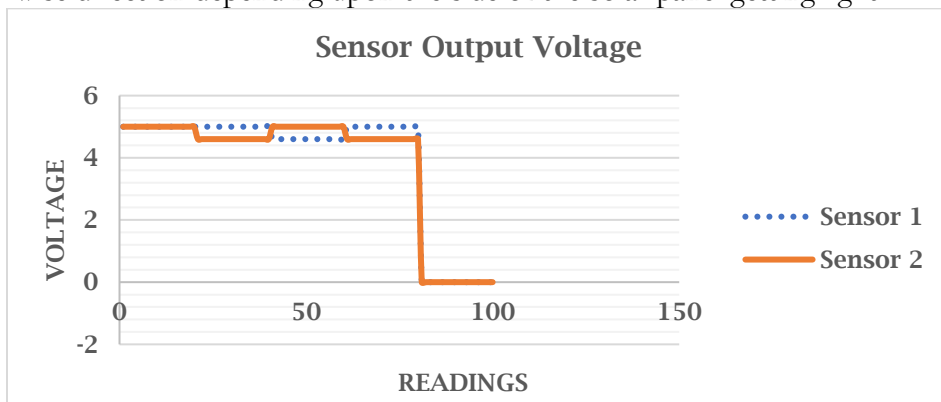

Figure 21. Sensor Output from differential PV sensors

The above graph shows the output of the differential PV sensors concerning the light incident on them. When light is incident on the differential PV sensors, their output becomes 5v. Which is fed into the Arduino. Whereas the side having a shade on top has a value slightly less than 5v. The code is generated such that it responds to this difference in voltage and actuates the system until both the solar panels get an equal voltage values of 5v.

Discussion

Two lab mockup was developed to effectively track the position of the sun. In these lab mockups azimuth angle the tracking system was actuated with a controller. A single-axis solar tracking controller was developed because the model on which this controller is physically implemented has an elevation axis that is actuated manually.

For the sun tracking a comprehensive sun, angle study was conducted. This study was really helpful concerning the validation of the result. Since the position of the sun is changing continuously throughout the day. So, the tracking system should continuously track the sun with accuracy. When testing was done on the lab mockup the angle change of sun, as well as Tracker, is synchronized with less lag in angle change of tracker. The chronological system can also be implemented but it is not very efficient because the embedded data is on basis of a forecast sometimes these forecasts are not accurate. That is why a microcontroller was used. The monocrystalline solar panel was used as a differential PV sensor. Monocrystalline was used because for the location of Islamabad, Pakistan solar radiation is uniform, and also energy production is greater with this type of solar cell.

Drawbacks

The lab mockups that were developed have certain deficiencies. Since by testing both systems it was deduced that there is a lag in the tracker angle concerning the orientation of the sun. So, the tracker was not properly able to track the sun.

Weather conditions are also a source of drawback for these systems. Since both systems is placed open and have to face extremely harsh weather condition, the failure of the system is most likely to happen. The solution to this problem is the proper protection of the system. When LDR sensors are boxed for protection their efficiency decreases. Lab mockup with a differential PV sensor is a better option but it requires weekly maintenance because the efficiency of solar panels decreases when there are dust particles on them.

Efficiency Assessment

Both designs tracked the sun efficiently, one with an LDR sensor and the other with a differential PV sensor. With a bit of variation, both followed the sun's trajectory. But factors such as lifetime and cost are considered if efficiency is to be compared has a relatively low lifetime than differential PV sensors. Due to the lack of proper insulation, the reduction in performance over time is more likely to occur in LDR sensors. During the test, LDR sensors seem to have a delay in variation, which can affect the accuracy of the results. On the other hand, PV sensors are relatively more costly than LDR sensors. So, overall, differential PV sensors can be preferred in the system over LDR due to reliability and better efficiency.

Conclusions

The need for energy in modern times is ever-increasing. To meet this demand, non-renewables are proving to be not enough. To overcome this problem, the focus has now shifted to renewable resources. The main factors for this change are the abundance of renewables and their ability to provide. Taking solar energy can provide ten times the needs of the whole planet. The problem lies with utilization. It is not as efficient to have a static solar panel system. Rather, an active solar panel serves the job in a better way. The system gets an increase in its efficiency when the system is rotated in two axes. The actuation of the elevation axis is dictated by the amount of angle difference throughout the year. Taking the location of

Islamabad, the angle change is not drastic and thus this axis can be left to be operated manually whereas the azimuth axis must be actuated using a motor. To design a tracking system, first lab mockups must be devised. This will help in understanding the tracking of the sun. The first system was based on LDR sensors and a Micro servo motor. This system was able to detect a close light source efficiently. Moreover, it was also able to detect a tube light in a room. However, this system was unable to detect the position of the sun. This was due to the digital input from the sensors. The second proposed model was more realistic. It consisted of a DC motor rather than the micro servo motor. Also, a motor driver was used to ensure that the motor can rotate clockwise and in an anticlockwise direction. This system, coupled with an appropriate gear system, can be used in the actuation of a real system. The system uses differential PV sensors. Due to logistical issues, 10v solar panels were used and their voltage was stepped down using buck converters. This was done because Arduino only accepts 5v input at maximum. This system, while tested, produced clockwise and anticlockwise motions of the motor. This validated the purpose of the system. Hence, this dual axis solar tracking system, when implemented, can increase the efficiency of a solar panel system.

Recommendations

There are mainly two categories of algorithms followed by a solar tracker microcontroller, Active and Chronological. Both have their pros and cons. Active algorithms locate the sun and follow the trajectory, while chronological algorithms run on the input data of sun location. During a cloudy day, the active algorithm cannot precisely locate the sun resulting in decreased performance of solar panels. On the other hand, the chronological algorithm is complex to run, keeping track of sunrise and sunset all year round. A solution to this dilemma is recommended as a hybrid algorithm instead; which uses an active algorithm on sunny days and is shifted to chronological algorithms on cloudy days. Two of the devices are the Beagle Bone Black chip along with the Arduino and another is the Pyranometer sensor that reduces the irradiance angle of rays causing fewer solar rays to be reflected, thus focusing more rays on the solar panel. Both these could be used in the future for a better-performing system. Countries like Pakistan have a lot of air pollution causing a depletion of the dust layer on solar panels, ultimately reducing the performance of solar panels over time. Hence a dust-removing system can be installed that will clean the solar panel at regular intervals to maintain the performance, in future work.

REFERENCES

- [1] M. O. KARAAGAC, H. OĞUL, and F. BULUT, “Sinop İli Koşullarında Monokristal ve Polikristal Fotovoltaik Panellerin Değerlendirilmesi,” *Türk Doğa ve Fen Derg.*, no. June, pp. 176–181, 2021, doi: 10.46810/tdfd.855488.
- [2] S. Battersby, “News Feature: The solar cell of the future,” *Proc. Natl. Acad. Sci. U. S. A.*, vol. 116, no. 1, pp. 7–10, Jan. 2019, doi: 10.1073/PNAS.1820406116.
- [3] Y. Rambhawan and V. Oree, “Improving the dual-axis solar tracking system efficiency via drive power consumption optimization,” *Appl. Sol. Energy 2014 502*, vol. 50, no. 2, pp. 74–80, Aug. 2014, doi: 10.3103/S0003701X1402011X.
- [4] A. Mohammed and A. Hanieh, “Automatic Orientation of Solar Photovoltaic Panels,” no. February, 2015.
- [5] “PD: 3D Sun-Path.”
- [6] N. H. Shah, “Aurdino based wireless display board using gsm technology,” no. February 2018, 2020.
- [7] L. Louis, “Working Principle of Arduino and Using it as a Tool for Study and Research,” *Int. J. Control. Autom. Commun. Syst.*, vol. 1, no. 2, pp. 21–29, 2016, doi:

10.5121/ijcacs.2016.1203.

- [8] “What is Servo Motor?- Definition, Working And Types - Engineering Choice.”
- [9] J. A. H. Mazhar. S, Nafeh. A, “Prospects of Biosynthetically produced Nanoparticles in Biocontrol of Pests and Phytopathogens: A review,” *Int. J. Innov. Sci. Technol.*, vol. 4, no. 2, pp. 552–563, 2022.
- [10] “In-Depth: Interface L298N DC Motor Driver Module with Arduino.”
- [11] “L298N Motor Driver Module Pinout, Datasheet, Features & Specs.”
- [12] “Buck Converter: Basics, Working, Design and Operation.”



Copyright © by authors and 50Sea. This work is licensed under Creative Commons Attribution 4.0 International License.