



Optimal Selection of Reactive Power for Single Tuned Passive Filter Based on Curve Fitting Technique

Original
Article

Muhammad Shahzad Bajwa¹, Muhammad Usman Keerio¹, Riaz Hussain Memon¹, Noor Hussain Mugheri¹, Kamran Ali Samo²

¹Quaid-e-Awam University of Engineering, Science and Technology Nawabshah

²Quaid-e-Awam University of Engineering, Science and Technology Larkana Campus

* **Correspondence:** Muhammad Shahzad Bajwa, shahzadbajwa@quest.edu.pk

Citation | Bajwa. S. M, Kerio. U. M, Memon. H. R, Mugheri. H. N, Samo. A. K, "Optimal Selection of Reactive Power for Single Tuned Passive Filter Based on Curve Fitting Technique". International Journal of Innovations in Science and Technology. Special Issue PP 12-23

Received | June 02, 2022; **Revised** | June 23, 2022; **Accepted** | June 25, 2022; **Published** | June 26, 2022.

This research presents the Optimal Reactive Power (Q_c) selection for a single-tuned passive filter. DC drives are very popular in the industrial zone due to their high performance, flexibility, easy control, and low cost. DC drives operate by giving supply from an AC utility and AC to DC can be converted using the AC-DC converter. But this conversion introduces harmonics in the input supply current that affect the performance of the DC drive and also cause serious problems for the overall power quality of the system. Many researchers are searching for the appropriate solutions to mitigate this cause. A passive filter is one solution to minimize or avoid harmonics from entering the electrical system. The key aspect of the passive filter design has been a difficult task. The parameters of the passive filter largely depends upon selecting the suitable value of reactive power (Q_c). In this paper, the Simulink model of an AC-DC converter based on a separately excited dc motor is used as an industrial load, and a curve fitting technique has been used to select the optimal value of reactive power (Q_c) for the passive filter. The simulation results and analysis show that optimal selection of reactive power for single tuned passive filter using the proposed technique is very effective by taking international standards limits for harmonic distortion.

Keywords: DC drives, Harmonic distortion, Optimal selection, Curve fitting technique, Passive filter, MATLAB/Simulation

Acknowledgment.

The first author would like to thank the Quaid-e-Awam University of Engineering, Science and Technology Nawabshah, Sindh, for this research work and this work

has not been published or submitted to other journals, and all authors are agreed with the content of manuscript, and this work will be published in this journal.

CONFLICT OF INTEREST:

The authors of this paper declare no conflict of

interest.

Project details. Nil

Author's Contribution.

Conceptualization, M.S.B and M.U.K.; Methodology, M.S.B.; Investigation, M.S.B.; writing, reviewing, final manuscript, M.S.B, M.U.K, R.H.M, N.H.M, K.A.S.



INTRODUCTION

In many industrial facilities, DC drives can account for a large portion of the energy load Industries such as rubber, plastics, textiles, paper, oil, printing, metal, chemicals, and mining employ DC drives due to their efficient nature. These drives are still the most prevalent type of motor speed control for applications requiring very fine control over vast speed ranges with high torques. On the other end, dc drives also generate harmonic distortion [1]. Steady-state variations in voltage or current wave shape from its perfect sinusoidal wave of fundamental frequency (usually 50Hz) are called harmonic distortion. Mathematically, the relationship between the frequencies of the harmonic signal and the frequency of the fundamental signal is generally expressed as Total Harmonic Distortion (THD) [2]. An electrical power distribution system is intended to work with constant frequency but when nonlinear loads like AC-DC power converter-based drives are linked with the system, there is no smooth change that occurs in current with voltage, resulting an unnecessary number of harmonics being generated, that produces voltage and current distortions. Due to these harmonics, the power system becomes spoiled. It generates numerous adverse effects like overheating of equipment, malfunction of sensitive equipment, flickering lights, overheating of equipment, reduced system capacity, reduced power factor, extreme current in the neutral wire and overheating of the motor, etc., [3], [4]. Harmonic distortion in an electrical system cannot be entirely mitigated. Still, it can be minimized in many ways, like the installation of passive filters, active filters, and hybrid filters in the system [5]. Of these filters, the most common choice is the implementation of a passive filter for harmonic mitigation. The passive filter requires no power supply and simple arrangement that shows the most excellent cost- effective characteristic with all other mitigation techniques [6].

The essential components utilized in the passive filters are the capacitor and inductor. To remove the harmonic distortion, they are arranged in such a way that they fulfill the resonance condition. In a resonance condition, the capacitive and inductive reactance are equal, and this arrangement presents low impedance for the harmonic current so that it will flow in the filter-branch instead of the supply system. The basic arrangement of a single tuned passive filter is as shown in Figure.1 [7].

The single tuned passive filter is commonly and frequently used in manufacturing industries to mitigate harmonic distortions. This type of filter is simpler and economical as compared to other filters [8].

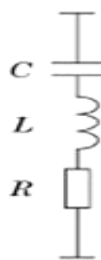

Figure 1.
Single
tuned
passive
filter [7]

For designing the single tuned passive filter, it is significant to determine the appropriate value of capacitor, dependent upon suitable selected reactive power (Q_c) that enables it to mitigate harmonics [9].

The objectives of this study are first to obtain simulated ac-dc based drive harmonic distortion data and then select the optimal value of reactive power (Q_c) for single tuned passive filter and implement in Simulink model.

Therefore, it is convenient here to list the parameters or quantities compulsory for the passive filter design that can be written as

1. Reactive power (Q_c) in VAR
2. Harmonic order (h)
3. Supply voltage (V_s) in volts
4. Fundamental frequency (f) in Hz
5. Quality Factor (Q_L)

The following five Eqs. (1) to (5) are the mathematical expressions to determine the values of capacitance (C), inductance (L), and resistance (R) for a single-tuned passive filter.

$$X_C = \frac{V_s^2}{Q_c} \quad (1)$$

$$C = \frac{1}{2\pi f X_C} \quad (2)$$

$$X_L = \frac{X_C}{h^2} \quad (3)$$

$$L = \frac{X_L}{2\pi f} \quad (4)$$

$$R = \frac{X_L}{Q_L} \quad (5)$$

The optimal design of passive filters means reducing the harmonic distortion in voltage and current while keeping the cost of the filter at a minimum. Therefore, it is very necessary to determine the suitable value of capacitive reactive power (Q_c) in Var [10].

A lot of work has been done by researcher for mitigation of harmonics distortion and improvement in power quality of electrical system. Zubi et al. presented a comparative performance analysis of common existing forms of passive harmonic filters for three-phase diode-rectifier usually found in the devices such as adjustable speed drives. This analysis consists of parameters such as the magnitudes and waveforms of input voltage and input current, values of rectifier voltage regulation, total harmonic distortion for voltage and current signals, power factor, line voltage unbalance sensitivity, energy efficiency, size, and cost. Moreover, they also investigated the problem associated with harmonic-excited series or parallel resonance and the unbalanced operation performance due to unbalance operating conditions [11]. Azazi et al. reviewed active and passive methods of power factor improvement for low power AC to DC converter in single-phase system but not show the information on total harmonic distortion (THDi), active and reactive power after obtaining the result [12]. Diwan et al. presented a harmonic filter design procedure to mitigate the harmonics produced by six pulse rectifier loads. It is suggested in their work that before building the final configuration, different alternatives should be considered. They have used the criteria of voltage and current ratings of each of the filter components for their performance evaluation [13]. Bhonsle and Kelkar presented measurement of harmonic distortion indices for domestic loads like laptop, personal computer, LCD, etc. It is also found that if the configuration of system will change, then harmonic profile of the system will also be changed, the result of that can be the detuning of passive filter, which indicates the restriction of passive filters [14]. Memon et al. proposed two passive filters, single tuned filters, and high pass filters, to reduce current harmonics due to the three-phase ac to dc converter used in industrial power systems. Four single tuned filters are designed to suppress the lower harmonic orders, such as 5th, 7th, 11th, and 13th, and one second order high pass filter is designed to eliminate the high harmonics order. These proposed filters reduce the supply current harmonics to less than 5% at low and medium voltage levels per limits specified in IEEE 519-1992 standards [15]. Pyakuryal and Matin derived a mathematical

formula for a combined (LC) filter at output of AC/DC converter. They used a software model to verify the mathematical formula when a filter contains only capacitor or only inductor elements. If the mathematical formula from the software model is verified, a method is derived for designing a collective inductive-capacitive elemental filter to suppress the ripple at the required level [16]. Anooja et al. presented design and simulation of passive filter for diode rectifier and SCR rectifier in six pulse and twelve pulse configurations through MATLAB/Simulink, where there exist a drawback in their method that number of passive filters used are five, which need to be reduced due to the cost factor [17]. Maheswaran, et al. presented designing procedure of passive filters to correct the power factor and reduce harmonic distortion in two pulse rectifier system using genetic algorithm, but not convey the result of power factor before harmonic mitigating process and also it is valid for constant load [18]. Baitha and Gupta presented the design method of single and double tuned passive filters. They found the double tuned passive filter is more efficient in mitigation of harmonics as compared to single tuned passive filter. Moreover, they also found that the value of supply current harmonics (THDi) decreases with an increment in the value of quality factor (QL) without much raising the overall RMS current of the supply [19]. Soomro and Almelian presented the optimal single tuned passive filter design for 3 phase rectifier loads. The optimal parameters of this filter were calculated based on calculated value of reactive power (QC) by using Lagrange interpolation method, but not shown that value throughout [20]. Campos et al. in their work presented a method of designing filter for harmonic distortion reduction as well as power factor correction. The benefit of designed filters is that it do not count any reaction with frequency variations other than tuned frequency, but require large reactive power to achieve the similar efficiency with lower reactive power. Moreover, with the increment of more harmonic orders, power loss at resistor side is less while it is more for overall number of filters [21]. Kececioglu et al. determined that hybrid passive filters are a combination of parallel and series configuration that can handle current source type and voltage source type variable loads. But the drawback is that they are not appropriate for suddenly changing nonlinear loads [22]. Almutairi and Hadjiloucas suggested that a single tuned passive filter could be installed in typical industrial power systems, and constrained optimization can be used to determine the optimal sizing of the passive filter to reduce current and voltage harmonics to a satisfactory level with added advantage to improve the load power factor [23]. Fahmi et al. utilized the single tuned passive filters to mitigate the harmonics in the plastic processing factory. The simulated result shows that designed filters can reduce THD from 15.55% to 4.77%, according to the limit of IEEE 519-1992 standards [10]. Ziad Ali et al. used a wide range of reactive power-sharing approaches among multiple-arm passive filters to get the best result [24]. Mageed et al. investigated the impact of harmonics produced due to various household electrical appliances. It showed electronic household appliances generated the highest voltage and current waveform distortion and causes of major harmonics and suggested installing an active filter in parallel with the house-hold appliances [25]. Haur et al. applied the iterative graphical method to obtain the most suitable Q -factor value for the passive filter to minimize the loss [26]. Chamberlin and Azebaze investigated the efficiency of the single tuned and broad-band LC passive filters in the frequency domain through their impedance versus frequency characteristics as well as in the time domain through an electrical system [27].

Though considerable work has been done to reduce harmonic distortion using Passive filters due to nonlinear loads, the optimal solution becomes an issue.

The problem is that if the small value of Q_c is chosen, then total harmonic distortion is not reduced enough. In contrast, the greater value of Q_c may have an overcompensating

effect, meaning both quantities have an inverse relation. Therefore, an optimal value of QC has to be determined to obtain the THD<5 as recommended according to the international standard limit.

The paper is organized as follows: Section I presents the effects of harmonics on system due to AC-DC converter-based dc drive load and design criteria of the passive filter. Section II presents the way of finding function through curve fitting technique. Section III discuss the proposed method of selecting optimal value of reactive power (Q_c) for the passive filter and its implementation through Simulink; finally, section IV concludes the paper.

Curve Fitting Technique

Data acquired from simulation-based worked or an experimental, we assume there is a function f(x) which pass through that data points and find that function curve fitting methods can be used.

Curve fitting methods have two types.

- Interpolation
- Curve fitting

Interpolation:

It connects the data dots. We can design and join the dots if the data is reliable. This is piecewise linear interpolation. Figure 2 shows an example of a graph of a function with interpolation.

While it is a set of small joints from one spot to the other, it doesn't provide very good results in data with random error (scatter).

Curve fitting:

A series of data points used to find the "best fit" line or curve is known as curve fitting, also called regression analysis. An equation generated from curve fit can be used to get points most of the time anywhere along the curve, as shown in Figure.3. In some cases, the main concern is about finding an equation, instead, to smooth the data, you may just want to use a curve fit and improve your plot's form [28].

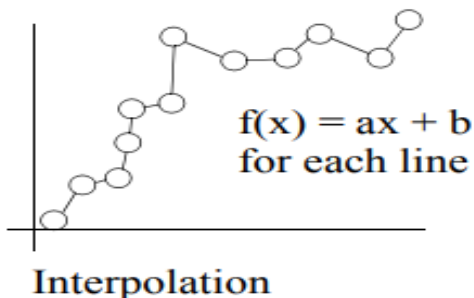

Figure 2. Graph of function with interpolation [28]

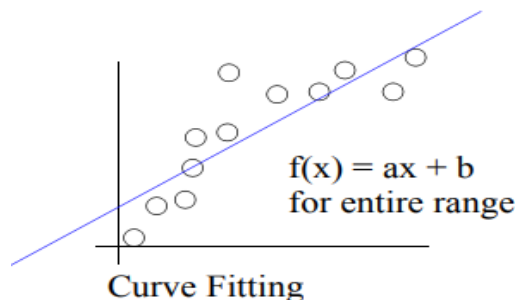

Figure 3. Graphical view of function with curve fitting [28]

In actual practice, there are several functions used. A straight line is enhanced, and many functions like polynomials, exponentials, and trigonometric are applicable for different applications. Consequently, how we can possibly enlighten better enhancement as well as how possibly we can select a suitable model [29].

A term is used in curve fitting called the error related to the fitted data shown in Figure.4.

Residual = data - fit

$$\text{e.g error} = \sum_{i=1}^n (y_i - (ax_i + b))^2$$

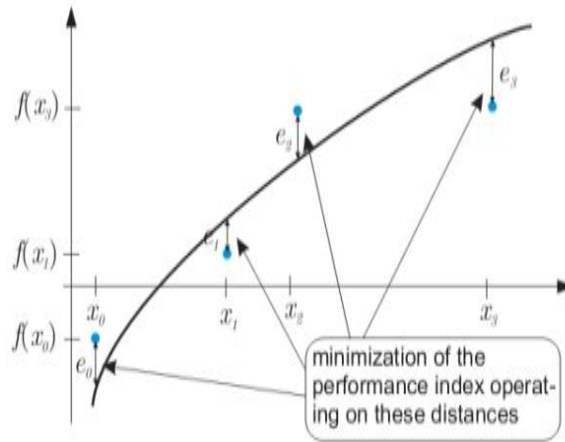

Figure 4. Least square curve fit [29]

Flow Chart Diagram

The following flow chart shows the research methodology as shown in Figure.5. First of all, a MATLAB/Simulink based model of an AC-DC power converter-based drive has been developed and acquired the measurement data such as Individual Harmonic Order (IHD), THD in voltage and current signal, then passive filter is designed using the optimal value of reactive power (Q_c). Finally the results were compared before and after installation of optimal passive filter.

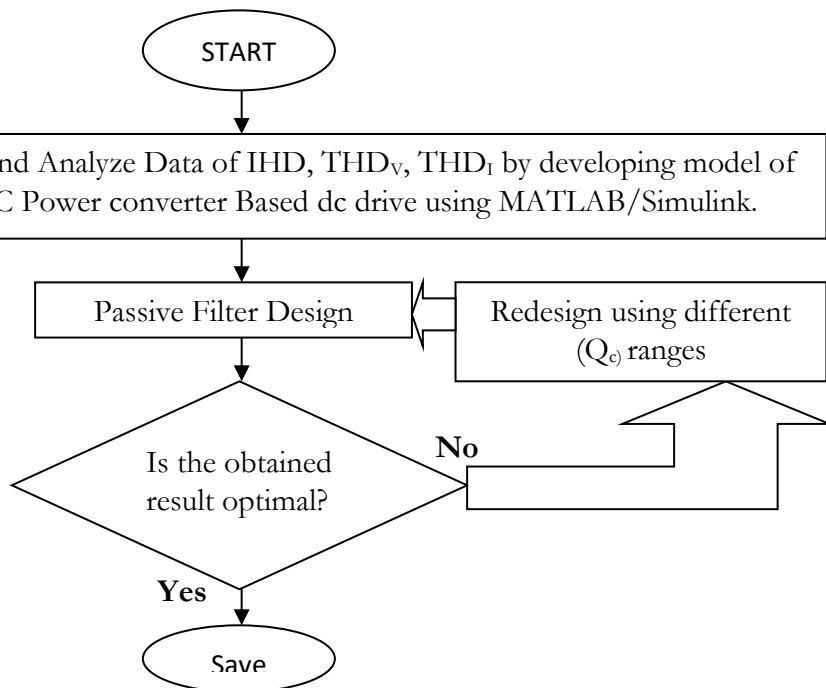

Figure 5. Flow chart of Proposed Methodology

Material and Methods.

The source of harmonic, such as an AC-DC converter based *separately excited* DC motor, can be simulated without and with a passive filter using MATLAB/Simulink, as shown in Figure.6. Table. 1 lists the DC motor parameters that were used in the simulink model.

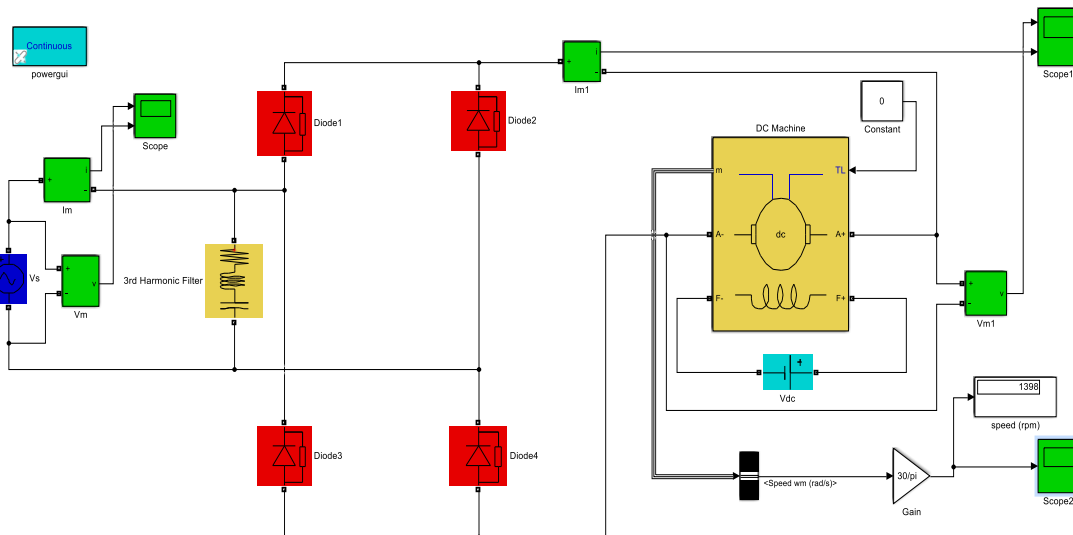

Figure 6. Simulation model of AC-DC converter based *separately excited* DC motor

Table 1. Parameters used in Simulink Model

Parametrs	Values
Rated armature voltage(rms)	240V
Supply frequency	50Hz
Power Rating	5Hp
Field Resistance (R_f)	281.3 Ω
Field inductance (L_f)	156H
Rated Field Voltage	150V
Armature Resistance (R_a)	2.518 Ω
Armature Inductance (L_a)	0.028H
Rated Speed	1750rpm

Result and discussion.

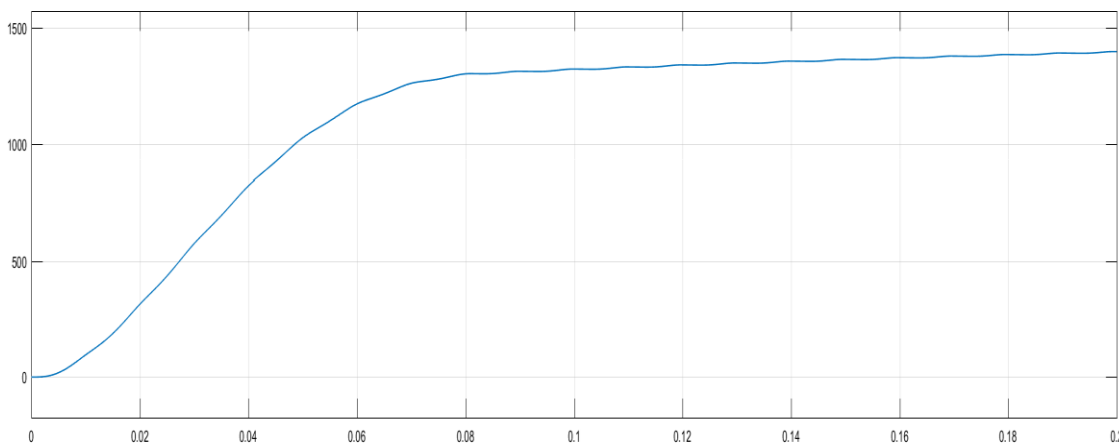

Figure 7. Speed (in rpm) vs Time (in second) graph

At the starting period, speed increased with time, and at after 0.1 seconds, speed attained its steady-state value, which was about 1398 rpm. As the motor was operating on a no-load condition and supplied through an uncontrolled full-wave rectifier, the speed remained constant, as shown in Figure.7.

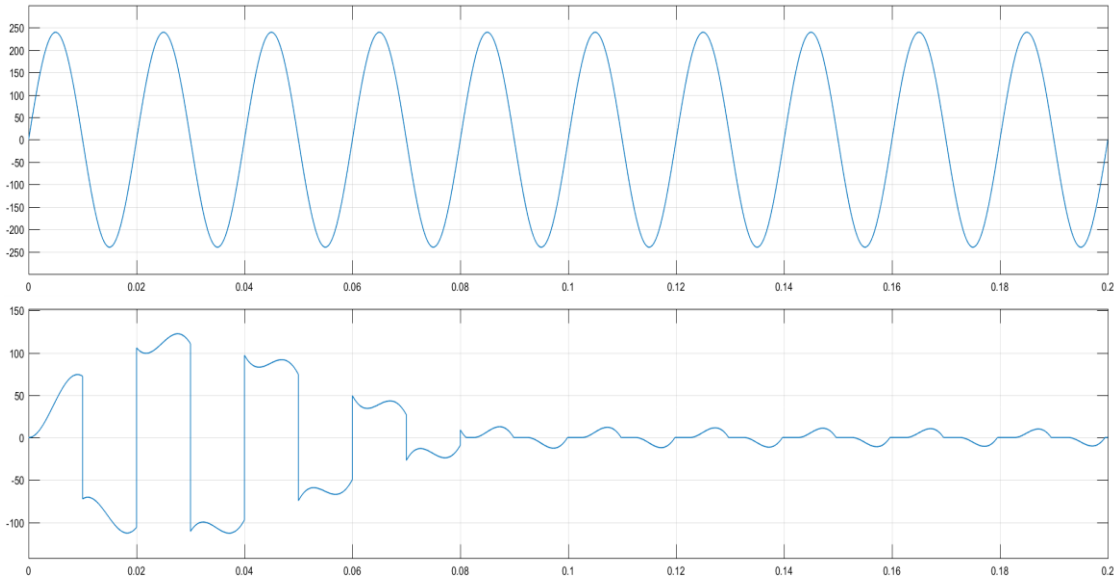

Figure 8. Input supply voltage and current waveforms without passive filter

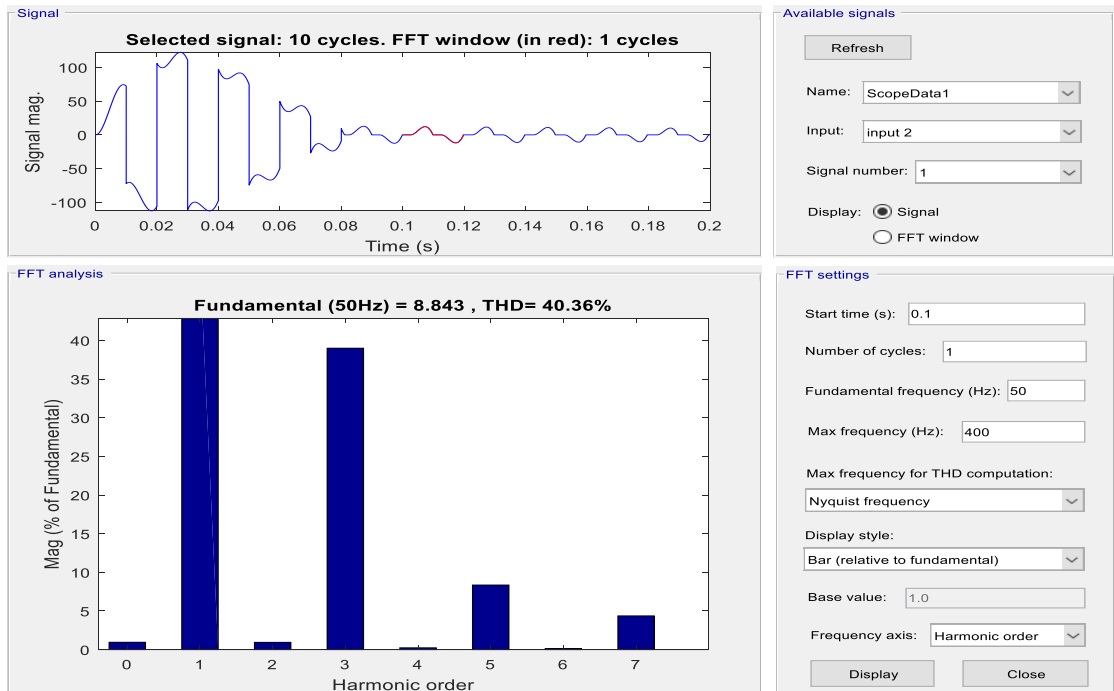

Figure 9. FFT analysis of input supply current without passive filter

It can be observed that without using a passive filter, the current waveform becomes significantly distorted as compared to the voltage waveform, as shown in Figure.8. Therefore, by FFT analysis, the THD_i was obtained as 40.36%, as shown in Figure.9. According to international standards, the values of THD_i were observed violated from the standard limit. Therefore, a passive filter was installed in Simulink model at the input source side to prevent the flow of harmonic components into the system. The optimal value of reactive power for designing passive filter was selected using the curve fitting technique.

Optimal Selection of Reactive Power (Qc) for Single- Tuned Passive Filter

Optimal design of passive filters means reducing the harmonic distortion in voltage

and current (THD<5) while keeping the cost of the filter at a minimum. Therefore, it was necessary to determine the suitable value of capacitive reactive power (Q_c) [20]. For this, a range of Q_c was chosen, i.e., 3000 to 30000 with a step size of 3000. The chosen range of Q_c was considered based upon the active and reactive power taken by the load. As a result of plotting Q_c vs THDi using the curve fitting technique by cf tool in MATLAB, the graph shown in Figure.10 and Eq. (6) is obtained.

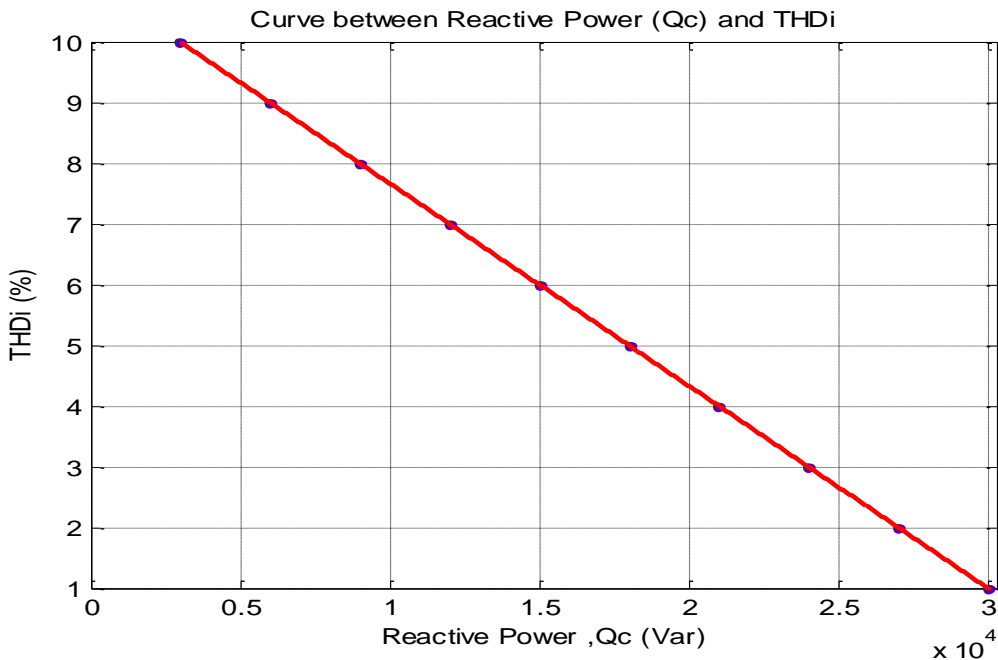

Figure 10. Curve between Reactive Power (Q_c) and THDi

$$THD_i = -0.0003333Q_c + 11 \quad (6)$$

SSE (Sum of Squared Error): 1.428e-28

As the obtained Eq. (6) has a SSE value that is very low, therefore, this mathematical relationship can be used for calculating the optimal value of reactive power to obtain the lowest possible percentage of THD.

From the simulation results, it was observed that the 3rd harmonic order is more dominant. Therefore, a 3rd order single tuned filter is designed using Eq. (1) to Eq. (6). Table 2. shows the optimal values for the 3rd order single tuned passive filter.

Table 2. 3rd order single tuned passive filter

Filter Elements	C(uF)	L(mH)	R(Ω)
Values	1000	1	0.02

After installation of the designed passive filter, the input supply current reaches to sinusoidal waveform as shown in Figure.11. The response of this filter is observed from the frequency spectrum that 3rd harmonic order has been reduced effectively. In contrast, THDi reduced from 40.36% to 4.51%, as shown in Figure.12 and Table.3.

The simulation results show that after using an optimal passive filter, the THDi is within the desired permissible limit without much change in the speed of the DC motor.

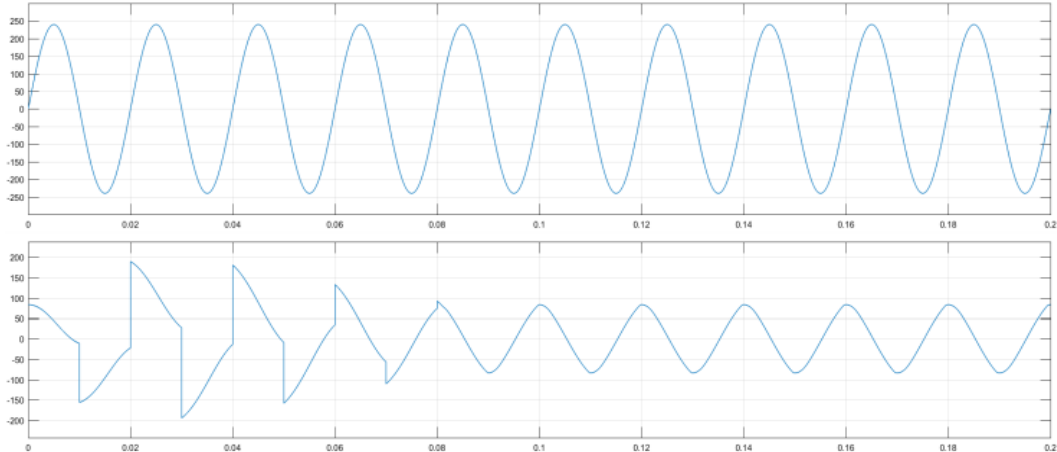

Figure 11. Input supply voltage and current waveforms with designed passive filter

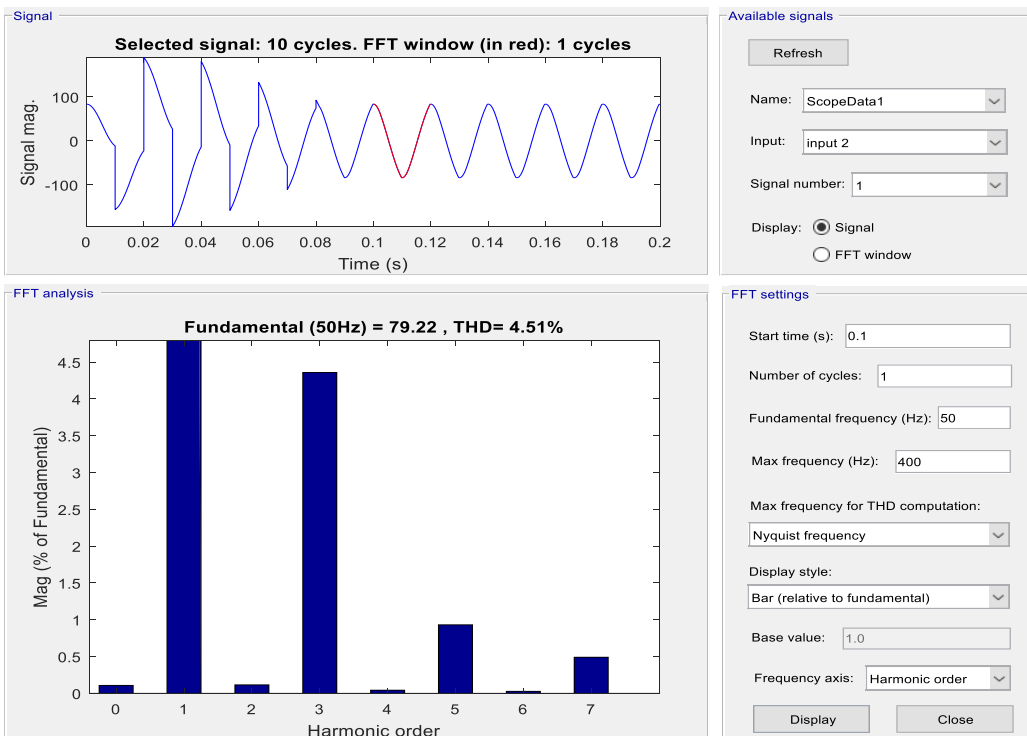

Figure 12. FFT analysis of input supply current with passive filter

Table 3. Comparison of THD_i before and after optimal passive filter installation

Index term	Before passive filter	After passive filter
THD _i	40.36%	4.51%

Conclusion.

DC drive loads can have harmonic distortion problem, resulting in the need for a harmonic filter to avoid excessive current distortion. The passive harmonic filter can be sized based on the reactive power of the capacitor element.

From the simulation results, it can be proved that the designed filter gives efficient results by mitigating 3rd order harmonics from 38.5% to 4.1%, while THD_i of source current reduced from 40.36% to 4.51% as the recommended harmonic limit according to international standards. Curve fitting technique allows the user to quantify the harmonic

distortion and calculate the THD function by taking different values of reactive power within limits.

REFERENCES

- [1] N. Qasim, "DC Motor Drive with P, PI, and Particle Swarm Optimization Speed Controllers," *Int. J. Comput. Appl.*, vol. 166, no. 12, pp. 42–45, 2017, doi: 10.5120/ijca2017914032.
- [2] M. S. Bajwa, A. P. Memon, J. A. Ansari, and M. T. Bhatti, "An Experimental Investigation Based On Mathematical and Software Modeling Of Total Harmonic Distortion in Personal Computer," no. June, 2016.
- [3] S. Saha, S. Das, and C. Nandi, "Harmonics Analysis of Power Electronics Loads," *Int. J. Comput. Appl.*, vol. 92, no. 10, pp. 32–36, 2014, doi: 10.5120/16046-5228.
- [4] K. Nikum and A. Wagh, "HARDWARE Implementation of Step-Switched SVCs to Correct Power factor and Mitigate Harmonics for Large DC Variable Loads," *J. Inst. Eng. Ser. B*, vol. 101, no. 6, pp. 777–789, Dec. 2020, doi: 10.1007/S40031-020-00476-3/TABLES/5.
- [5] I. A. Channa, M. A. Koondhar, N. M. Mughal, M. S. Bajwa, S. A. A. S. Bukhari, and M. I. Jamali, "Simulation and Analysis of Active Power Filter for Mitigation of Power Quality Problems in a Wind Based Distributed Generation," *J. Appl. Emerg. Sci.*, vol. 11, no. 1, p. 11, Jun. 2021, doi: 10.36785/2021111429.
- [6] K. K. Srivastava, S. Shakil, and A. V. Pandey, "Harmonics & Its Mitigation Technique by Passive Shunt Filter," no. 2, pp. 325–332, 2013.
- [7] S. M. Khudher, I. bin Aris, M. Othman, and N. Mailah, "Output-Input Hybrid Passive Filter Design for Electric Vehicle Charging Station," *Coll. Eng. Univ. Mosul*, vol. 26, no. 2, pp. 132–142, Oct. 2021, doi: 10.33899/RENGJ.2021.129599.1084.
- [8] B. Park, J. Lee, H. Yoo, and G. Jang, "Harmonic Mitigation Using Passive Harmonic Filters: Case Study in a Steel Mill Power System," *Energies 2021, Vol. 14, Page 2278*, vol. 14, no. 8, p. 2278, Apr. 2021, doi: 10.3390/EN14082278.
- [9] T. Adrikowski, D. Bula, and M. Pasko, "Selection of method for reactive power compensation and harmonic filtering in industrial plant," *2017 Prog. Appl. Electr. Eng. PAEE 2017*, no. August, 2017, doi: 10.1109/PAEE.2017.8009010.
- [10] Z. M. Ali, F. Q. Alenezi, S. S. Kandil, and S. H. E. Abdel Aleem, "Practical considerations for reactive power sharing approaches among multiple-arm passive filters in non-sinusoidal power systems," *Int. J. Electr. Power Energy Syst.*, vol. 103, pp. 660–675, Dec. 2018, doi: 10.1016/J.IJEPES.2018.06.044.
- [11] & F. V. P. R. H. M. Zubi, R.W. Dunn, "Comparison of different common passive filter topologies for harmonic mitigation," in *45th International Universities Power Engineering Conference UPEC*, 2010, pp. 1–6.
- [12] H. Azazi and E. EL-Kholy, "Review of passive and active circuits for power factor correction in single phase, low power AC-DC converters," *Int. Middle East Power Syst. Conf.*, no. 10, p. 154, 2010, [Online]. Available: <http://www.sdaengineering.com/mepcon10/papers/154.pdf>.
- [13] & A. P. V. S.P. Diwan, H.P. Inamdar, "Simulation Studies of Shunt Passive Harmonic Filters: Six Pulse Rectifier Load-Power Factor Improvement and Harmonic Control," *ACEEE Int. J. Electr. Power Eng.*, vol. 2, no. 1, pp. 1–6, 2011.
- [14] D. C. Bhonsle and R. B. Kelkar, "Harmonic pollution survey and simulation of passive filter using MATLAB," *2011 Int. Conf. Recent Adv. Electr. Electron. Control Eng. IConRAEECE'11 - Proc.*, pp. 230–236, 2011, doi: 10.1109/ICONRAEECE.2011.6129785.
- [15] Z. A. Memon, M. A. Uquaili, and M. A. Unar, "Harmonics Mitigation of Industrial Power System Using Passive Filters," no. May, 2016, [Online]. Available: <http://arxiv.org/abs/1605.06684>.
- [16] and M. M. S. Pyakuryal, "Filter design for AC to DC converter," *Int. Ref. J. Eng. Sci.*, vol.

- 2, no. 6, pp. 42–49, 2013.
- [17] C. L. Anooja and N. Leena, “Passive Filter For Harmonic Mitigation Of Power Diode Rectifier And SCR Rectifier Fed Loads,” *Int. J. Sci. Eng. Res.*, vol. 4, no. 6, pp. 1615–1621, 2013, [Online]. Available: <http://www.ijser.org>.
- [18] and L. A. K. D. Maheswaran, N. Rajasekar, “Design of Passive Filters for Reducing Harmonics Distortion and Correcting power factor in Two Pulse Rectifier System Using Optimization,” *J. Theor. Appl. Inf. Technol.*, vol. 62, no. 3, pp. 720–728, 2014.
- [19] A. Baitha and N. Gupta, “A comparative analysis of passive filters for power quality improvement,” *Proc. IEEE Int. Conf. Technol. Adv. Power Energy, TAP Energy 2015*, pp. 327–332, Aug. 2015, doi: 10.1109/TAPENERGY.2015.7229640.
- [20] D. M. Soomro and M. M. Almelian, “Optimal design of a single tuned passive filter to mitigate harmonics in power frequency,” *ARPJ. Eng. Appl. Sci.*, vol. 10, no. 19, pp. 9009–9014, 2015.
- [21] & P. F. R. B.P. de Campos, L.A. de Sousa, “Mitigation of harmonic distortion with passive filters,” in *17th International Conference on Harmonics and Quality of Power (ICHQP)*, 2016, pp. 646–651.
- [22] O. F. Kececioğlu, H. Acikgoz, and M. Sekkeli, “Advanced configuration of hybrid passive filter for reactive power and harmonic compensation,” *Springerplus*, vol. 5, no. 1, 2016, doi: 10.1186/s40064-016-2917-7.
- [23] S. H. M. Almutairi, “Application of Single Tuned Passive Filters in Distribution Networks at the Point of Common Coupling,” *Int. J. Electr. Comput. Energy. Electron. Commun. Eng.*, vol. 11, no. 2, pp. 176–182, 2017, [Online]. Available: <internal-pdf://122.62.192.58/Application-of-Single-Tuned-Passive-Filters-in.pdf%0Ahttp://waset.org/publications/10006390>.
- [24] M. I. Fahmi, U. Baafai, A. Hazmi, and T. H. Nasution, “Harmonic reduction by using single-tuned passive filter in plastic processing industry,” *IOP Conf. Ser. Mater. Sci. Eng.*, vol. 308, no. 1, 2018, DOI: 10.1088/1757-899X/308/1/012035.
- [25] H. Mageed, A. S. Nada, S. Abu-Zaid, and R. S. Salah Eldeen, “Effects of Waveforms Distortion for Household Appliances on Power Quality,” *Mapan - J. Metrol. Soc. India*, vol. 34, no. 4, pp. 559–572, 2019, doi: 10.1007/s12647-019-00352-6.
- [26] and W. J. R. Y.K. Haur, T.J. Son, L.K. Yun, “Design of Single-Tuned Passive Harmonic Filter to Meet Ieee-519 Standard By Means of Quality-Factor Manipulations,” *Int. J. Adv. Sci. Technol.*, vol. 29, no. 1, pp. 1364–1379, 2020.
- [27] C. S. Azebaze Mboving, “Investigation on the work efficiency of the lc passive harmonic filter chosen topologies,” *Electron.*, vol. 10, no. 8, 2021, doi: 10.3390/electronics10080896.
- [28] M. J. H. Rawa, D. W. P. Thomas, and M. Sumner, “Mathematical Modeling of the Harmonic Distortion Caused by a Group of PCs Using Curve Fitting Technique,” *Proc. - UKSim-AMSS 17th Int. Conf. Comput. Model. Simulation, UKSim 2015*, pp. 386–390, Sep. 2016, doi: 10.1109/UKSIM.2015.41.
- [29] M. S. Bajwa and M. U. Keerio, “Modeling Of Factors Influencing Harmonic Distortion Based on Simulation Model of Personal Computer,” vol. 4, no. 3, pp. 173–180, 2020.



Copyright © by authors and 50Sea. This work is licensed under Creative Commons Attribution 4.0 International License.