



Comparison of Various Waveform Contenders of 5G Wireless Communication Based on OFDM

Raksha Vishnoi¹, Saurabh Gaur², Ashish Verma²

¹PG Student, ²Associate Professor

ECE Department, M.I.T., Ujjain, Madhya Pradesh, India

ABSTRACT

This paper presents an extensive and fair comparison among the most promising waveform contenders for the 5G air interface which includes- Filtered OFDM, Filter-bank multi carrier (FBMC), universal filtered multi-carrier (UFMC) has been compared with OFDM in terms of spectral efficiency and bit error rate using mat lab. The disadvantages of OFDM have been addressed and it has shown that (fofdm), (UFMC), (FBMC) could be a more effective solution. FBMC is a method for improving out of band (OOB) characteristics by filtering each subcarrier, it is also expected to improve the Inter-Carrier Interference (ICI) characteristics while UFMC is a method for improving OOB characteristics by filtering each block.

Keywords: FBMC, UFMC, ICI, KPIs and OOB

I. INTRODUCTION

The evolution of internet and the growing demand of high data rate users have given Dynamic spectrum access networks a widespread attention in the recent years. orthogonal frequency division multiplexing (OFDM) based on multi-carrier has high-power out-of-band (OOB). This characteristic causes adjacent channel interference (ACI). OFDM uses a wide guard band in order to avoid ACI. It decreases spectral efficiency when a number of mobile devices simultaneously access a base station. Next generation mobile communication system requires high-level key performance indicators (KPIs). It is difficult for OFDM to satisfy the KPIs. Mobile subscribers are demanding an enormous increase of the data rates and the capacity is to be increased up to 1,000 times within the next 5 years.

Several new waveforms are already proposed for 5G: (FBMC), (UFMC) & (f-OFDM). The main objective of all these modulations is to reduce the out of-band emissions and take advantage of those gap bands allowing narrowband communication to be carried out in the resources left unused by bandwidth [1].

II. Orthogonal Frequency Division Multiplexing (OFDM)

In OFDM multicarrier system, the frequency spectrum of the subcarriers is overlapped with the least frequency spacing and the orthogonality is attained amid the various subcarriers. The input stream is subdivided into parallel data streams by means of the serial to parallel (S/P) converter, that are then passed into an inverse fast Fourier transformation (IFFT) block to produce time sequence of the streams. Consequently, by totalling a cyclic prefix (CP), the OFDM symbol time sequences are extended [1],[2]. The CP is a copy of the latter portion of the symbol that is added in the start of the sequence and should be greater than the network deferral spread in order to diminish the inter symbol interference (ISI) produced by the influx of various OFDM symbols with distinct delay. The resultant digital signal is transformed into analog form and transmitted over the channel. At the receiver end, the signal is reconstructed into digital form and the fast Fourier transform (FFT) is achieved in the received streams after eradicating the CP. Finally, the parallel streams are collected into a single stream as the original transmitted one. Some of the disadvantages of OFDM are enumerated below:

1. Decreased spectral efficiency owing to the CP employed.

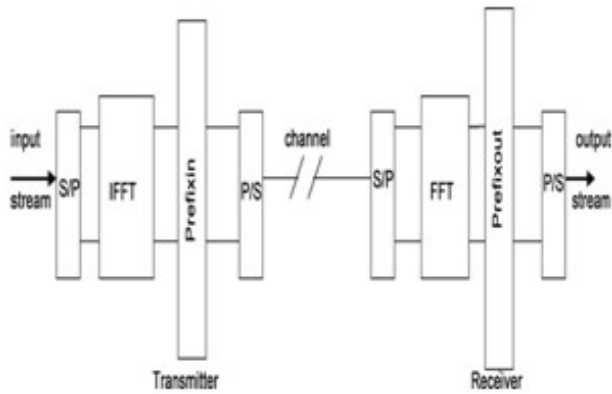

Figure 1: Block Diagram of OFDM

carriers so as to multiplex in both time and frequency domain. OFDM data are generated by taking symbols in the spectral space using M-PSK, QAM, etc, and convert the spectra to time domain by taking the Inverse Discrete Fourier Transform (IDFT). Since Inverse Fast Fourier Transform (IFFT) is more cost effective to implement. It is basically a multi-carrier modulation technique [2].

III. Filtered – OFDM (F-OFDM)

F-OFDM is one of the proposed waveforms for the evolution towards 5G. In OFDM the effect of large out of band emission due to the rectangular shaping of temporal signals is largely alleviated in F-OFDM by using transmit filter which is cascaded after the modulator. Filtering process in f-OFDM is done through specially filters which are suitably designed to suppress high side lobes thereby making Filtered-OFDM a bandwidth efficient technique. Besides this, filtering operation becomes challenging when the spectrum pulses are not continuous and the filter is redesigned for each available chunk of spectrum. Hence, we will introduce ISI in Consecutive

2. High spectral leakage owing to the rectangular windowing.
3. Interference amid the unsynchronized signal in the neighboring bands.

OFDM is a widely used modulation and multiplexing technology, which has become the basis of many telecommunications standards including wireless local area networks (LANs), digital terrestrial television (DTT) and digital radio broadcasting in the world. It is a multicarrier transmission scheme which divides the bandwidth into different sub-channels known as sub-

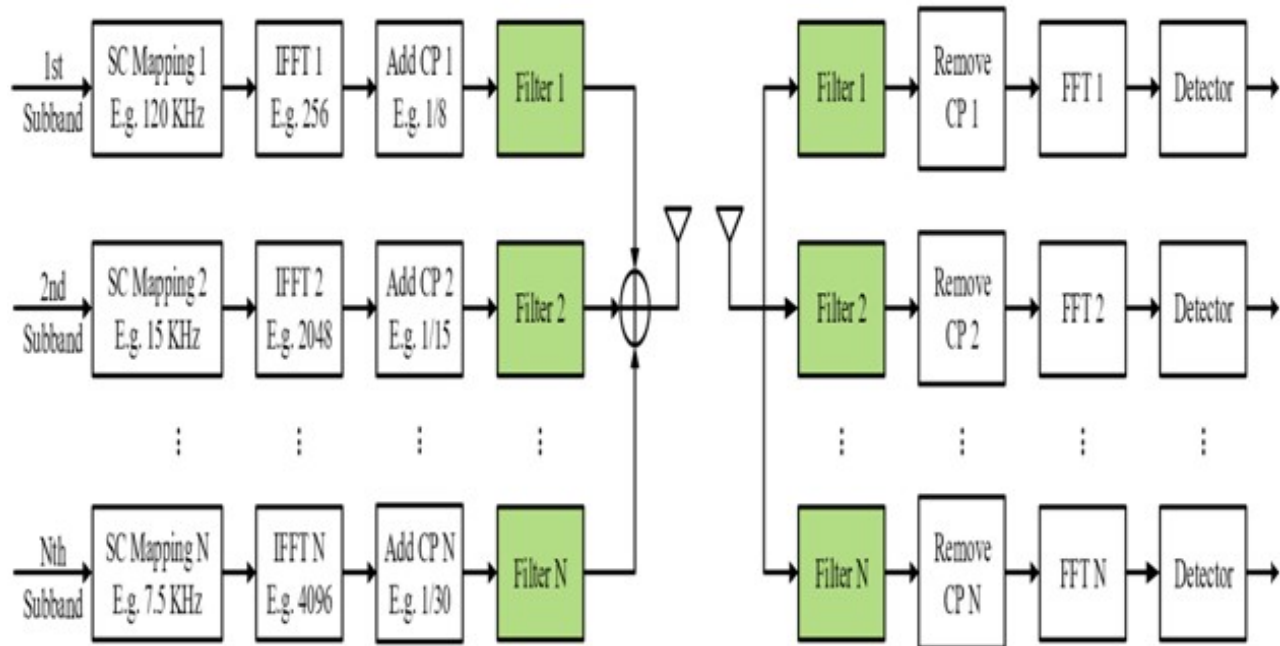

Figure 2: Block Diagram of f-ofdm Transceiver [5]

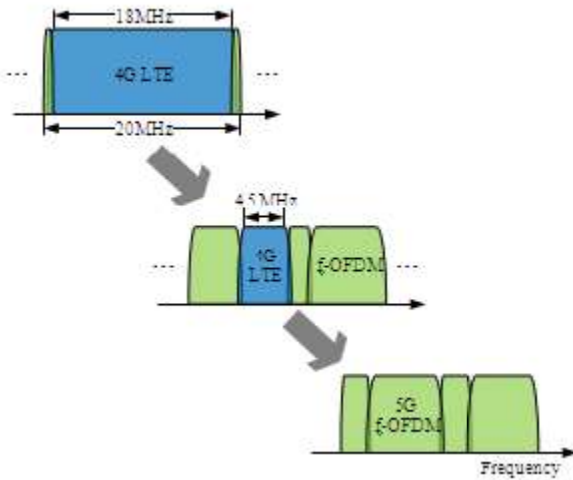

Figure 3: Possible evolution path from OFDM in 4G LTE to f-OFDM in 5G

Symbols arriving at the receiver. In order to cope with this ISI we can enlarge the Cyclic prefix (CP) so as to cancel both, the effect of multipath and filtering. Enlarging the CP means reducing the performance by introducing a larger overhead, so we need to avoid it. The main idea is filtering the OFDM signal due to which the out-of-band emissions will be reduced making adjacent gap bands available and easier to use for other purposes. f-OFDM provides both forward and backward compatibility. In f-OFDM the available bandwidth is divided in several sub-bands, each one having different numerology and accommodating different kind of services. Even though OFDM is considered to be spectrum efficient, still 10% of allocated BW is wasted to allow attenuation of the signal.

To achieve orthogonally both in frequency and time in OFDM, extra signalling to assure synchronization is needed, especially for uplink transmission. In this way, we brake intentionally the time-domain orthogonally between consecutive f-OFDM symbols for lower OOB. Consequently, asynchronous transmission between sub-bands is now supported by Filtered – OFDM [2],[3].

IV. FBMC

The FBMC technique overcomes the limitations of OFDM by adding generalized pulse shaping filters which delivers a well localized sub channel in both time and frequency domain. Consequently, FBMC systems have more spectral containment signals and offer more effective use of the radio resources where no CP is required. It can be seen that the filter banks

on the transmitter side and the receiver side consist of an array of N filters that processes N input signals to give N outputs. The filter bank used at the transmitter side is called synthesis filter bank and the filter bank used in receiver side is called analysis filter bank. Filter bank multicarrier applies filtering on a per-subcarrier foundation [4]. The plus point of this technique is that without using the CP, it can give an efficient and better performance than conventional OFDM. With such attributes, it is considered as one of the most capable modulation technique for 5G. This technique employs a bank of filters and the data in parallel pass through each filter. In FMBC offset-QAM is applied to comply with the factual orthogonality rule with the result FBMC exhibits non-orthogonality in the complex domain. OFDM with offset Quadrature amplitude modulation (OFDM/OQAM) is the most common FBMC technique. This filter method can be implemented in two ways—in the frequency domain, or in the time domain.

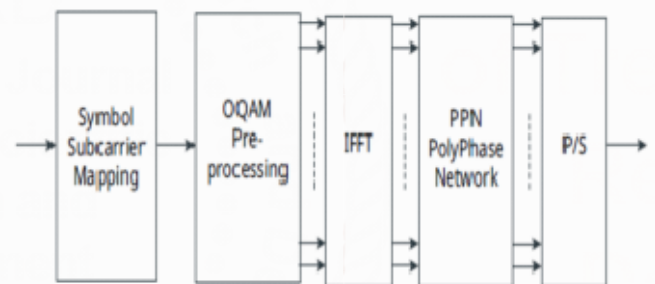

Figure 4: FBMC modulation block

To fix the iFFT length to the same total sub-carrier number, time domain processing method is suitable and Poly Phase Network (PPN) is used [5]. FBMC using this narrowband filtering has greatly improved

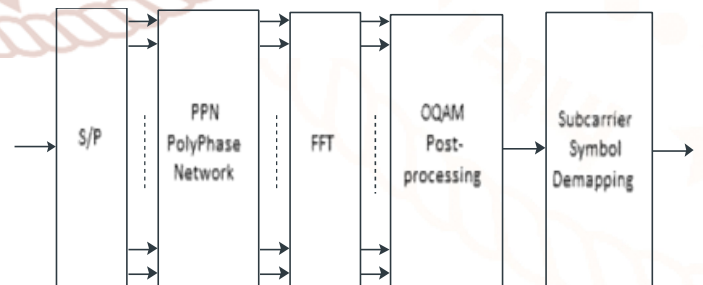

Figure 5: FBMC Demodulation Block

OOB Characteristics on the other hand, the number of filter taps required to improve the characteristics is about four times the total sub-carrier number, creating a four times processing latency in a PPN

configuration. Accordingly, although FBMC is problem-free for bit pipe communications such as video streaming, it has lower transmission efficiency for short packets.

V. UPMC

Universal filtered multi-carrier (UPMC) is a waveform for future wireless systems. It is also known as unified filtered OFDM (UF-OFDM). UPMC is the method that combines the advantages of orthogonality OFDM and filter bank in FBMC. FBMC is problem-free for bit pipe communications such as video streaming, it has lower transmission efficiency for short packets. Instead of filtering each carrier like in FBMC, we have to filter a block of carriers called sub-band [4],[6]. Each sub band

contains a number of carriers; filter length will be depending upon the width of sub-band. In the UPMC system, the complex symbols are generated from the base - band modulator. UPMC divides the band assigned for a user in smaller sub-bands, and after filtering them separately; they are summed and sent through the channel. Due to this filter tails, UPMC uses a null transmission or known as zero padding in front of each symbol, in order to cope with both, the delay spread of the channel and filter. UF-OFDM is a method for improving OOB characteristics by filtering each block. The mapped signal is allocated to a predetermine number of blocks. To overcome the problems of the ofdm we should have a new waveform for replacing OFDM in 5G physical layer.

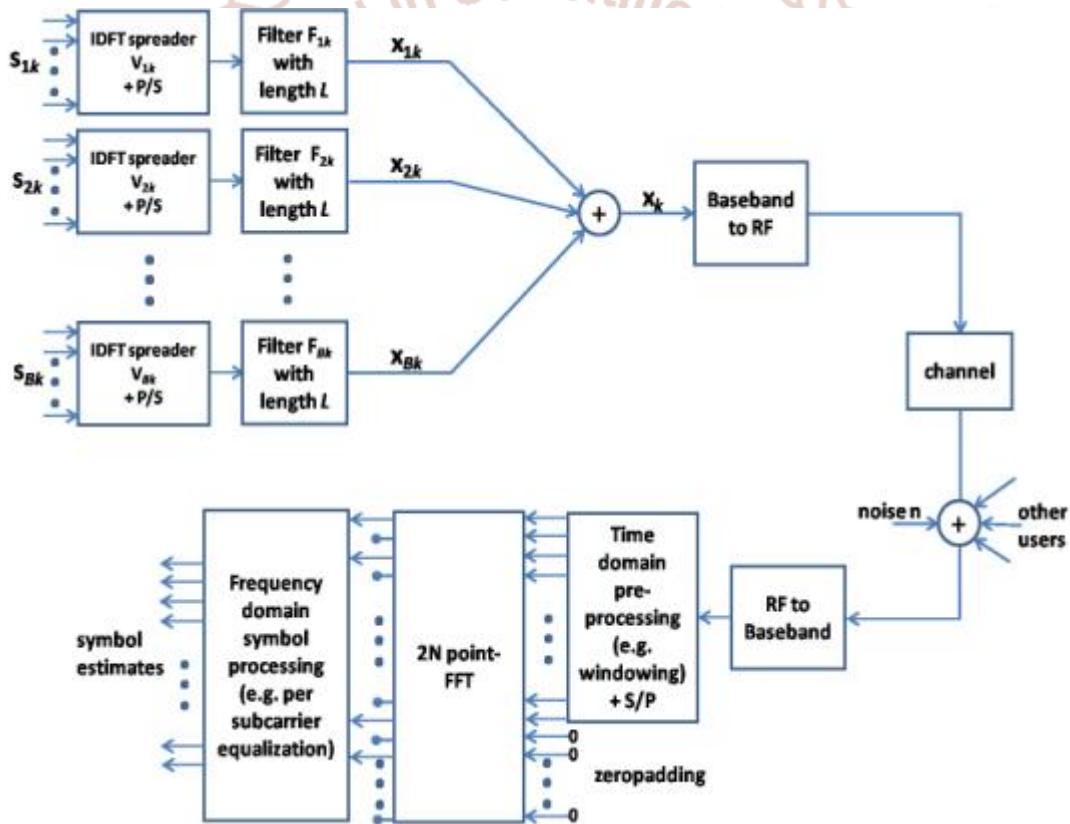

Figure 6: Block Diagram of UPMC Transceiver [7]

The new waveform should achieve the asynchronous reception and transmission, non - orthogonal waveforms for better spectral efficiency and low latency. The filter using in UPMC is DolphChebyshev of length 'L'.

VI. Simulation Results

Table 1: Simulation Parameter

1) Tool	Matlab
2) Modulation	Qpsk
3)FFT Size	612
4)CP Length	16 bit
5)Frequency	4 GHz
6)SNR	1 db to 25 db
7)Channel	AWGN

Figure 7 shows BER performances of each system.

The analysis compares bit error rate (BER) vs SNR graph of FBMC and UFMC with OFDM modulation. FBMC offers ways to overcome the known limitations of OFDM of reduced spectral efficiency and strict synchronization requirements. The benefits have led it to being measured as one of the modulation techniques for 5G communication structures. UFMC technique shows the least bit error rate as compared to the above methods and it is the best waveform contenders for 5G applications [8].

Figure 8 shows the evaluation of FBMC and UFMC with OFDM on the basis of spectral efficiency vs number of users. It has been shown that UFMC exhibits higher spectral efficiency. It is multi-carrier transmission scheme in order to overcome the ICI problem and improve the system performance [9]. Due to the use of cyclic prefix in OFDM, 10% of the bits are repeated, where as in UFMC, cyclic prefix is not used. This increases spectral efficiency. In UFMC, total bandwidth is divided into sub-bands. As number of subcarriers adding up in phase will be fewer in UFMC, the maximum power decreases.

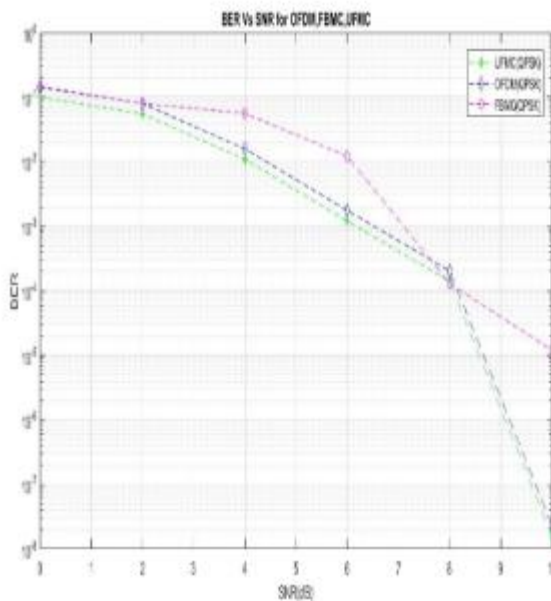

Figure 7: Graph of BER vs SNR for OFDM,FBMC and UFMC

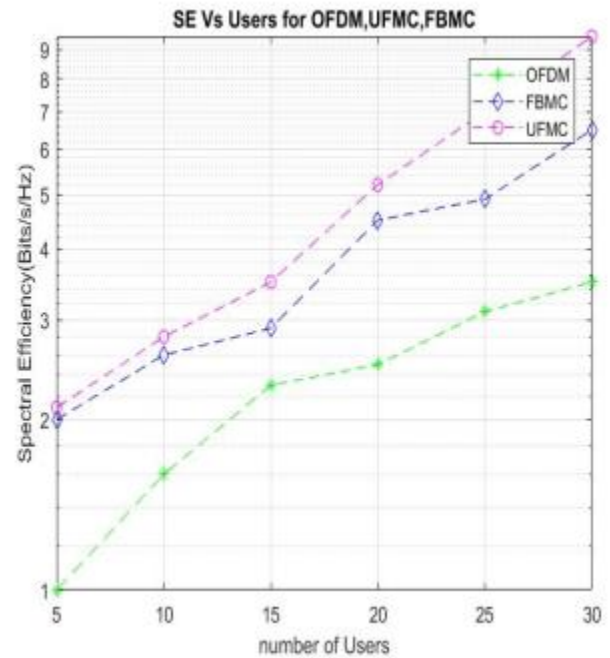

Figure 8: Graph of SE vs Users for OFDM,FBMC and UFMC.

VII. Conclusion

Mobile communication requirements are increasing with the upcoming 5G applications such as Tactile Internet, IoT and Fragmented Spectrum. In this paper, we have focused on spectrum efficiency and BER performance evaluation of OFDM, FBMC, and UFMC. FBMC provides filtering of each subcarrier, which requires very long filter length and it prevents ICI. Although FBMC has several advantages as compared to the current OFDM of LTE, it is still not the optimal solution. With UFMC the objective is to merge the advantages of FBMC and filtered OFDM and get rid of some disadvantages of them. It is based on the idea of filtering a block of sub carriers [8],[10]. Like FBMC, UFMC is robust to multi-user interference, exhibits higher spectral efficiency and better suited to fragmented spectrum than OFDM.

VIII. References

1. W. Chin, F. Zhong, R. Haines, "Emerging technologies and research challenges for 5G wireless networks," IEEE Wireless Commun., vol. 21, no. 2, pp. 106–112, Apr 2014.
2. J. Andrews, S. Buzzi, W. Choi, S. Hanly, A. Lozano, A. Soong, J. Zhang, "What will 5G be?" IEEE J. Select. Areas Commun., vol. 32, no. 6, pp. 1065–1082, Jun 2014.
3. A. S. ahin, I. G"uvenc, H. Arslan, "A survey on multi-carrier communications: Prototype filters,

- lattice structures, and implementation aspects, "IEEE Commun. Surveys Tutorials, vol. 16, no. 3, pp. 1312–1338, Aug 2014.
4. P. Banelli, S. Buzzi, G. Colavolpe, A. Modenini, F. Rusek, A. Ugolini, "Modulation formats and waveforms for 5G networks: Who will be the heir of OFDM?: An overview of alternative modulation schemes for improved spectral efficiency," IEEE Signal Process. Mag., vol. 31, no. 6, pp. 80–93, Nov 2014.
 5. 3GPP, "Technical specification 36.212," Tech. Rep., Jun 2015, v12.5.0.
 6. <https://www.metis2020.com> Mobile and Wireless Communications Enablers for the 2020 Information society.
 7. <http://www.5gnow.eu> 5th Generation Non-Orthogonal wave forms for asynchronous Signalling
 8. A. Loulou, M. Renfors, "Enhanced OFDM for fragmented spectrum use in 5G systems", Trans. Emerging Tel. Tech., vol. 26, pp. 31–45, 2015)
 9. F. Schaich, T. Wild, Y. Chen, "Waveform contenders for 5G suitability for short packet and low latency transmissions, IEEE Veh. Technology Conference Spring, pp. 1–5, Apr 2014.
 10. 10.G. Matz, H. Bölcskei, F. Hlawatsch, "Time-Frequency Foundations of Communications," IEEE Signal

